

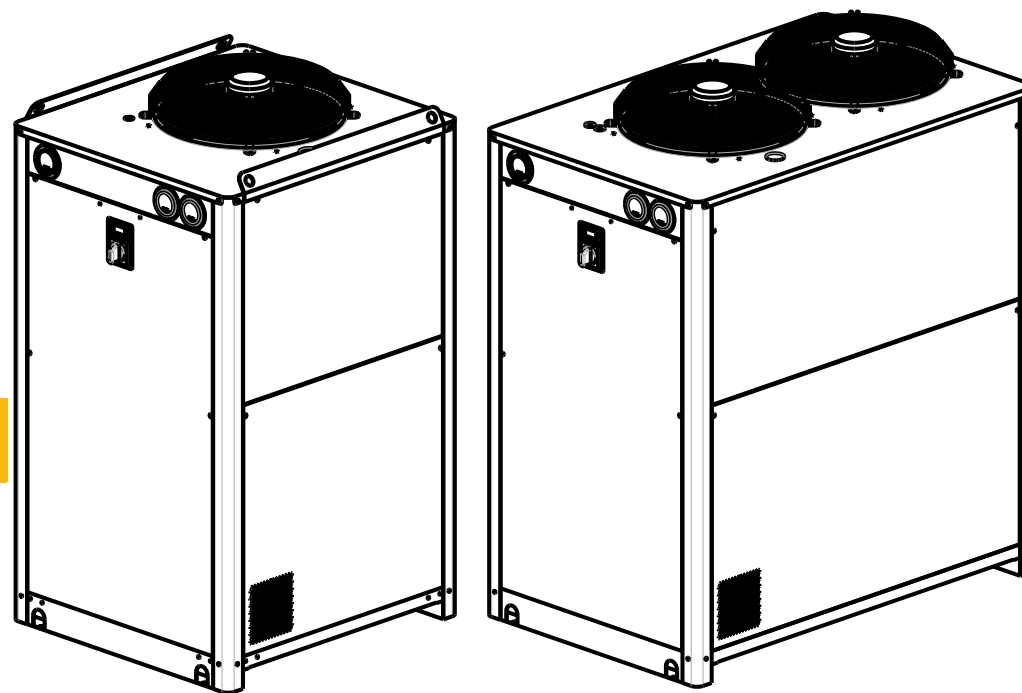

Hyperchill **Plus-E**

ICEP 008E
ICEP 011E
ICEP 015E
ICEP 022E
ICEP 027E

(60Hz)



EN User Manual
ES Manual de uso
FR Manuel d'utilisation

DATE: 02.12.2024 - Rev. 03
CODE: 398H271815Y60UL



Index

1 Safety	2
1.1 Importance of the manual.....	2
1.2 Warning signals.....	2
1.3 Safety instructions.....	2
1.4 Residual risks.....	2
2 Introduction	3
2.1 Transport.....	3
2.2 Handling.....	3
2.3 Inspection.....	3
2.4 Storage.....	3
3 Installation	3
3.1 Operating space.....	3
3.2 Versions.....	3
3.3 Water circuit.....	3
3.3.1 Checks and connection.....	3
3.3.2 Water and ethylene glycol.....	4
3.3.3 Expansion tank (only for ICEP005).....	4
3.4 Electrical circuit.....	5
3.4.1 Checks and connections.....	5
3.4.2 General alarm.....	5
3.4.3 ON/OFF remote.....	5
3.5 Water-cooled version (W).....	5
4 Control	6
4.1 Control panel.....	6
4.2 Meaning symbols.....	6
4.3 Starting the chiller.....	6
4.3.1 Adjustments at commissioning.....	6
4.4 Stopping the chiller.....	6
4.5 Parameter settings.....	7
4.5.1 Chiller parameters (CF9).....	7
4.5.2 Temperature control (CTP).....	7
4.5.3 Maintenance parameters (fint).....	7
4.5.4 Probe parameters (b1, b2).....	7
4.5.5 Alarm history (RLH).....	7
4.6 Change parameters (direct).....	8
4.6.1 Chiller parameters "CF9".....	8
4.6.2 Temperature control "CTP".....	13
4.6.3 Probe parameter "b1".....	14
4.7 Visualization of temperature probes.....	14
4.8 Setting clock/date.....	15
4.9 Alarm management.....	16
4.10 Alarm history.....	17
5 Maintenance	17
5.1 General instructions.....	17
5.2 Refrigerant.....	17
5.3 Preventive Maintenance Programme.....	18
5.4 Dismantling.....	18
6 Troubleshooting	19





7 Appendix	
7.1 Legend	
7.2 Installation diagram	
7.3 Handling, operating space	
7.4 Technical data	
7.5 Variables Modbus	
7.6 Dimensions	
7.7 Spare parts	
7.8 Circuit diagram	
7.9 Wiring diagram	

1 Safety

1.1 Importance of the manual

- Keep it for the entire life of the machine.
- Read it before any operation.
- It is subject to changes: for updated information see the version on the machine.

1.2 Warning signals



	Instruction for avoiding danger to persons.
	Instruction for avoiding damage to the equipment.
	The presence of a skilled or authorized technician is required.
	There are symbols whose meaning is given in the para. 7.

1.3 Safety instructions

 Every unit is equipped with an electric disconnecting switch for operating in safe conditions. Always use this device in order to eliminate risks maintenance.

 **The manual is intended for the end-user, only for operations performable with closed panels: operations like installation/commissioning/maintenance or that requiring opening with tools must be carried out by skilled and qualified personnel.**

 Do not exceed the design limits given on the dataplate.

  It is the user's responsibility to avoid loads different from the internal static pressure. The unit must be appropriately protected whenever risks of seismic phenomena exist. Only use the unit for professional work and for its intended purpose.

 The user is responsible for analysing the application aspects for product installation, and following all the applicable industrial and safety standards and regulations contained in the product instruction manual or other documentation supplied with the unit.

Tampering or replacement of any parts by unauthorised personnel and/or improper machine use exonerate the manufacturer from all responsibility and invalidate the warranty.

The manufacturer declines and present or future liability for damage to persons, things and the machine, due to negligence of the operators, non-compliance with all the instructions given in this manual, and non-application of current regulations regarding safety of the system.

The manufacturer declines any liability for damage due to alterations and/or changes to the packing. It is the responsibility of the user to ensure that the specifications provided for the selection of the unit

or components and/or options are fully comprehensive for the correct or foreseeable use of themachine itself or its components.

 **IMPORTANT: The manufacturer reserves the right to modify this manual at any time. For the most comprehensive and updated information, the user is advised to consult the manufacturer.**

1.4 Residual risks

The installation, start up, stopping and maintenance of the machine must be performed in accordance with the information and instructions given in the technical documentation supplied and always in such a way to avoid the creation of a hazardous situation.

The risks that it has not been possible to eliminate in the design stage are listed in the following table.

part affected	residual risk	manner of exposure	precautions
heat exchanger coil	small cuts	contact	avoid contact, wear protective gloves
fan grille and fan	lesions	insertion of pointed objects through the grille while the fan is in operation	do not poke objects of any type through the fan grille or place any objects on the grille
inside the unit: compressor and discharge pipe	burns	contact	avoid contact, wear protective gloves
inside the unit: metal parts and electrical wires	intoxication, electrical shock, serious burns	defects in the insulation of the power supply lines upstream of the electrical panel; live metal parts	adequate electrical protection of the power supply line; ensure metal parts are properly connected to earth
outside the unit: area surrounding the unit	intoxication, serious burns	fire due to short circuit or overheating of the supply line upstream of the unit's electrical panel	ensure conductor cross-sectional areas and the supply line protection system conform to applicable regulations

2 Introduction

The fan, pump and compressor motors are equipped with a thermal protector that protects them against possible overheating.

2.1 Transport

The packed unit must remain:

- Upright.
- Protected against atmospheric agents.
- Protected against impacts.

2.2 Handling

Use a fork-lift truck suitable for the weight to be lifted, avoiding any type of impact.

2.3 Inspection

- All the units are assembled, wired, charged with refrigerant and oil and tested in the factory.
- On receiving the machine check its condition: immediately notify the transport company in case of any damage.
- Unpack the unit as close as possible to the place of installation.

2.4 Storage

- Keep the unit packed in a clean place protected from damp and bad weather.
- Do not stack the units.
- Follow the instructions given on the package.

3 Installation

 For correct installation, follow the instructions given in par.7.

 The product installed must be suitably protected against fire risk (ref. EN378-3).

 **It is recommended that all chillers be fitted with adequate pre-filtration near the inlet water to the chiller.**

 **Liquids to be chilled**

The liquids to be chilled must be compatible with the materials used.

Examples of liquids used are water or mixtures of **water and ethylene or propylene glycols or oil**.

The liquids to be chilled must not be flammable.

If the liquids to be chilled contain hazardous substances (e.g. ethylene/propylene glycol), any liquid discharged from a leakage area must be collected, because it is harmful to the environment. When draining the hydraulic circuit, comply with the current regulations and do not disperse the contents in the environment.

3.1 Operating space

 Leave a space of 1.5 m around the unit.

Leave a space of at least 2 metres above the refrigerator in models with vertical emission of condensation air.

3.2 Versions

Air version: Axial fans (A)

Do not create cooling air recirculation situations.

Do not obstruct the ventilation grilles.

The ducting of extracted air is not recommended for versions with axial fans.

3.3 Water circuit

3.3.1 Checks and connection

 Before connecting the chiller and filling the circuit, check that all the pipes are clean. If not, wash them out thoroughly.

  **If the plumbing circuit is of the closed type, under pressure it is install a safety valve set to: 6 bar.**

 Always install mesh filters on the water inlet and outlet pipelines.

 If the hydraulic circuit is intercepted by automatic valves, protect the pump with an anti-hammering system.

 If the hydraulic circuit is emptied for shut-down periods we recommend that you add lubricating fluid to the pump's impeller to avoid the risk of blockage when it is re-started. In case the impeller is blocked then you should unblock it manually.

Remove the rear cover of the pump and carefully turn the plastic fan. If the impeller is stuck then remove the fan and turn the impeller shaft directly. After un-blocking the impeller re-assemble the fan and cover.

Preliminary checks

1. Check that any shut-off valves in the hydraulic circuit are open.
2. In the case of a closed water circuit, check that an expansion tank of suitable capacity has been installed.

Connection

1. Connect the cooler to the inlet and outlet piping, using the special connections located on the back of the unit.

We recommend the use of flexible unions to reduce system rigidity.

2. Fill the water circuit using the fitting provided on the rear of the chiller ().
3. The tank is equipped with a breather valve that should be operated manually when filling the tank. Also, if the hydraulic circuit has high points, install a vent valve at the highest points.
4. We recommend that taps are installed on the inlet and outlet pipes, so that the unit can be excluded for maintenance when necessary.
5. If the chiller works with an open tank, the pump must be installed on intake to the tank and on delivery to the chiller.

 **Warning (models 022-120): the machine is equipped with an automatic protection device for the tank.**

If the water inlet is inadvertently closed when the pump is running and the water outlet is open, air will enter the tank with the probable intervention of the level sensor. It will be necessary to vent the hydraulic circuit to eliminate the air.

Subsequent checks

1. Check that the tank and the circuit are completely full of water and that all the air has been expelled.

led from the system.

- The water circuit must always be kept full. For this reason, carry out periodic checks and top the circuit up if necessary, or install an automatic filling kit.

Water characteristics

If not provided in the supply, fit a mesh filter on the water inlet

 Water characteristics:

Temperature	>50°F (10°C)	CL ⁻	<50 ppm
ΔT IN/OUT	5-15°C	CaCO ₃	70-150 ppm
Max % glycol	40	O ₂	<0.1 ppm
PH	7.5-9	Fe	<0.2 ppm
Electrical conductivity	10-500 μS/cm	NO ₃	<2 ppm
Langelier saturation index	0-1	HCO ₃ ⁻	70-300 ppm
SO ₄ ²⁻	<50 ppm	H ₂ S	<0.05 ppm
NH ₃	<1 ppm	CO ₂	<5 ppm
		Al	<0.2 ppm

Please note that for special water types such as demineralized, deionized or distilled it is necessary to contact the manufacturer to verify which kind of chiller should be used since the standard material may not be suitable.

3.3.2 Water and ethylene glycol

If installed outdoors or in an unheated indoor area, it is possible that the water in the circuit may freeze if the system is not in operation during the coldest times of the year.

To avoid this hazard:

- Equip the chiller with suitable antifreeze protection devices, available from the manufacturer as optional accessories.
- Drain the system via the drain valve if the chiller is to remain idle for a prolonged period.
- Add an appropriate quantity of antifreeze to the water in circulation (see table).

Outlet water temperature [°C]	Ethylene glycol (% vol.)	Ambient temperature
4	5	-2
2	10	-5
0	15	-7
-2	20	-10
-4	25	-12
-6	30	-15
-10	40	-20

Sometimes the temperature of the outlet water is so low as to require the addition of ethylene glycol in the following percentages.

3.3.3 Expansion tank

To avoid the possibility of an increase or decrease in the volume of the fluid due to a significant change in its temperature causing damage to the machine or the water circuit, we recommend installing an expansion tank of suitable capacity.

The expansion tank must be installed on intake to the pump on the rear connection of the tank.

The minimum volume of an expansion tank to be installed on a closed circuit can be calculated using the following formula:

$$V = 2 \times V_{tot} \times (P_{t \min} - P_{t \max})$$

where

V_{tot} = vol. circuit total (in litres)

$P_{t \min}/\max$ = specific weight at the minimum/maximum temperature reached by the water [kg/dm³].

The specific weight values at different temperatures for glycol percentage values are given in the table

% glycol	Temperature [°C]						
	-10	0	10	20	30	40	50
0%	1.0024	1.0008	0.9988	0.9964	0.9936	0.9905	0.9869
10%	1.0177	1.0155	1.0130	1.0101	1.0067	1.0030	0.9989
20%	1.0330	1.0303	1.0272	1.0237	1.0199	1.0156	1.0110
30%	1.0483	1.0450	1.0414	1.0374	1.0330	1.0282	1.0230
40%	1.0636	1.0594	1.0525	1.0511	1.0461	1.0408	1.0350



Caution: When filling the system, take into account the capacity of the expansion vessel as well.

If the ambient air temperature at the chiller is less than -10°C then you must move the expansion tank to a protected ambient close to the water return side of the chiller. The safety valve and bleed valve must remain at the chiller.

3.4 Electrical circuit

3.4.1 Checks and connections



Before carrying out any operation on the electrical system, make sure that the appliance is disconnected from the electrical power supply.

All electrical connections must comply with the applicable regulations in force in the country of installation.

Initial checks

1. The power supply voltage and frequency must correspond to the values stamped on the chiller nameplate. The power supply characteristics must not deviate, even for brief periods, from the tolerance limits indicated on the electrical diagram, which are +/- 10% for the voltage; +/- 1% for the frequency.
2. The power supply must be symmetrical (the effective voltages and the phase angles of consecutive phases must be equal). The maximum permissible voltage imbalance is 2%

Connection

1. The electrical power supply must be connected to the chiller using a 4-wire cable, comprising 3 phase conductors and an earth conductor, with no neutral. For minimum cable section, see par. 7.
2. Pass the cable through the cable entry on the rear panel of the machine and connect the phase and neutral to the terminals of the main isolator switch (QS); connect the earth wire to the earth terminal (PE).
3. Ensure that supply cable has at its source protection against direct contact of at least IP2X or IPXXB.
4. On the supply line to the chiller, install a residual-current circuit breaker with a trip rating of (RCCB - IDn = 0.3A), with the current rating indicated in the reference electrical diagram, and with a short circuit current rating appropriate to the short circuit fault current existing in the machine installation area.
The nominal current In of the magnetic circuit breaker must be equal to the FLA with an intervention curve type D.
5. Max. grid impedance value = 0.274 ohm.

Subsequent checks

Check that the machine and the auxiliary equipment are earthed and protected against short circuit and/or overload.



Once the unit has been connected and the upstream main switch closed (thereby connecting the power supply to the machine), the voltage in the electrical circuit will reach dangerous levels.

Maximum caution is required!

3.4.2 General alarm

All the chillers are equipped with an alarm signalling system (see electrical diagram), comprised of a switching free contact in a terminal block: this may be used for the connection of an external audible or visual alarm, or used to provide an input signal for a logic control system such as a PLC.

3.4.3 ON/OFF remote

All the chillers can be connected to a remote ON/OFF control (par.7.):

- To enable the remote rif. n.16387
- As reference variable ON/OFF rif.n.8996





Note: do not enable together "Sup" and "Re" .

See the electrical diagram for the connection of the remote ON-OFF (par.7.)















4 Control

4.1 Control panel



-  UP button: press to increment the value of a selected, editable parameter.
-  DOWN button: press to decrement the value of a selected, editable parameter.
-  ESC button : to exit without saving; returns to the previous level;
PRESSED FOR 5s. ALARM RESET.
-  SET button : to exit and saving/ confirm the value; go to the next level; enter on Set Menu;
PRESSED FOR 5s. START CHILLER.

4.2 Meaning symbols

Symbol	Symbol status	function	Symbol	Symbol status	function	
	Lit up	Compressor ON		Lit up	Temperature value	
	Flashing	Compressor stand_by			Lit up	Pressure value
	Off	Compressor Off				Lit up
	Lit up	Allarm present		Off		Antefreeze heater Off
	Flashing	Warning or Alarm resetable				Lit up
	Off	No alarm			Off	Crankcase heater Off Compressor 1
	Lit up	Pump 1 ON			Lit up	Crankcase heater ON Compressor 2 (not present)
	Off	Pump 1 Off			Off	Crankcase heater Off Compressor 2 (not present)
	Lit up	Pump 2 ON (not present)			Lit up	Crankcase heater ON Compressor 1
	Off	Pump 2 Off (not present)			Off	Crankcase heater Off Compressor 1

4.3 Starting the chiller

1. Connect the power supply to the machine by turning the main isolator switch QS to ON.
2. Press the button "set" to start up.
3. Set the desired temperature on the controller. (par. 4.5.1)

Phases Monitor

If appears on display the alarm "E123", during the start up, the user must verify the wiring of the input terminals of the disconnecting switch.

4.3.1 Adjustments at commissioning

1. Water temperature setting, see heading 4.5.
2. Regulation of th pump
 - Verify correct operation of the pump, using the pressure gauge (read P1 and P0) and checking the pressure limit values (Pmax and Pmin) indicated on the pump data plate.
 - P1 = pressure with pump ON
 - P0 = pressure with pump OFF
 - $P_{min} < (P1 - P0) < P_{max}$
 - Example n°1.
 - Conditions:
 - closed circuit, pressure P0 = 2 bar
 - pump data plate values: Pmin 1 bar/ Pmax 3 bar
 - adjust the valve outlet to give a pressure of 3 bar $< P1 < 5$ bar
 - Example n°2.
 - Conditions:
 - open circuit, pressure P0 = 0 bar
 - pump data plate values: Pmin 1 bar/ Pmax 3 bar
 - adjust the valve outlet to give a pressure of 1 bar $< P1 < 3$ bar
3. Verify correct operation of the pump similarly under normal running conditions. Check also that the amperage of the pump is within the limits indicated on the data plate.
4. Switch off the chiller and proceed to top up the hydraulic circuit at the "SET" temperature.
5. Check that the temperature of the "treated" water does not fall below 5 °C and that the ambient temperature in which the hydraulic circuit operates does not fall below 5 °C. If the temperature is too low, add the appropriate quantity of glycol, as explained under heading 3.3.3.

 **ATTENTION !: before switching on the chiller pump, close the water outlet valve.**

Always keep the possible inlet valve open, if present.

After switching on the pump, slowly open the chiller water outlet valve and adjust the flow rate as described in point 4.3.1.

4.4 Stopping the chiller

When chiller operation is no longer required, turn the chiller off as follows: press the button "set" (5 Sec.) .

Do not turn off the main switch QS to ensure that any antifreeze protection devices will still receive electrical power.

4.5 Parameter settings

General

There are two levels of protection for parameters:

a) Direct User-(U): with immediate access, **User-changeable**;

b) Password protected Service-(S): password required for access, **(do not change)**.

4.5.1 Chiller parameters (CF9)

PARAMETER	CODE	TYPE	DEFAULT
Unit of measurement.	<i>AR</i>	U	<i>OFF</i>
Alarm relay management	<i>CFJ1</i>	U	<i>0</i>
Restore default parameters	<i>dEF</i>	U	<i>OFF</i>
Remote on / off enabling	<i>AR</i>	U	<i>0</i>
Software version	<i>VER</i>	U	<i>1.69</i>
Unit adress	<i>CF30</i>	U	<i>1</i>
Baud rate	<i>CF31</i>	U	<i>3</i>
Modbus protocol	<i>CF32</i>	U	<i>1</i>
Supervisor on / off enabling	<i>SUP</i>	U	<i>OFF</i>
Dinamic set point enabling	<i>ErD</i>	U	<i>OFF</i>

4.5.2 Temperature control (CTP)

PARAMETER	CODE	TYPE	DEFAULT
Temperature control set point (standard)	<i>SET</i>	U	<i>13.0</i>
Temperature "precision control" set point (standard)	<i>SET</i>	U	<i>20.0</i>
Temperature control differential (NOT present in configuration "precision control")	<i>dIF1</i>	U	<i>4.0</i>

4.5.3 Maintenance parameters (Mnt)

PARAMETER	CODE	TYPE	DEFAULT
Unit working hours	<i>UH</i>	U	-
Unit working hours (X1000)	<i>UHL</i>	U	-
Unit partial working hours	<i>UPH</i>	U	-
Unit partial working hours (X1000)	<i>UPHL</i>	U	-
Compressor working hours 1	<i>CIH</i>	U	-
Compressor working hours 1 (x1000)	<i>CIHL</i>	U	-

4.5.4 Probe parameters (bt 1, bt2)

Probe (bt 1)

PARAMETER	CODE	TYPE	DEFAULT
High temperature alarm (water)	<i>HR1</i>	U	<i>60</i>

Probe (bt2)

PARAMETER	CODE	TYPE	DEFAULT
High temperature alarm (water)	<i>HR2</i>	U	<i>60</i>

4.5.5 Alarm history (ALH 1)

PARAMETER	CODE	TYPE	DEFAULT
Alarm number	<i>HYSP</i>	U	-
See alarm code	<i>HYSC</i>	U	-
See day and month of the alarm	<i>HYSD</i>	U	-
See hour and minutes of the alarm	<i>HYSE</i>	U	-
bt1 temperature at time of the alarm	<i>HY51</i>	U	-
bt2 temperature at time of the alarm	<i>HY52</i>	U	-
SET conditions at time of the alarm	<i>HY53</i>	U	-

4.6 Change parameters (User)

4.6.1 Chiller parameters "CF9"

Unit of measurement.

Switch ON the chiller "ON" using the Main disconnect switch QS, and wait on display the indication "OFF". Press the buttons "esc" "set" together to enter on "U" parameters.	
Parameter "PAR" appears. Press the button "set" to enter.	
Parameter "CF9" appears. Press the button "set" to enter.	
Parameter "R1" appears. Press the button "set" to enter	
The default value is "OFF" = °C Use the buttons "⏴" and "⏵" to select the unit of measurement. OFF : temperature = C°, Celsius ; pressure = Bar; On : temperature = °F, Fahrenheit; Pressure =PSI	
Press the button "set" to confirm.	
Automatically return to "R1" The parameter has now been stored. Press the button "esc" to exit, three time.	

Alarm management

Switch ON the chiller "ON" using the Main disconnect switch QS, and wait on display the indication "OFF". Press the buttons "esc" "set" together to enter on "U" parameters.	
Parameter "PAR" appears. Press the button "set" to enter.	
Parameter "CF9" appears. Press the button "set" to enter.	
Parameter "R1" appears. Use the buttons "⏴" and "⏵" to select "CFJ1" parameter.	
Press the button "set" to enter.	
The default value is "0" Use the buttons "⏴" and "⏵" to select the alarm relay management (par. 4.5.1- Tab.1)	
Press the button "set" to confirm.	
Automatically return to "CFJ1" The parameter has now been stored. Press the button "esc" to exit, three time.	

Tab.1 Alarm relay management (CFJ1.)

0	Relay normally deactivated, excited by an alarm.
1	Relay normally excited (also with control OFF), deactivated by an alarm.
2	Relay normally excited (only with control ON), deactivated by an alarm or with control OFF.

Default parameters

Switch ON the chiller "ON" using the Main disconnect switch QS, and wait on display the indication "OFF". Press the buttons "esc" "set" together to enter on "U" parameters.	
Parameter "PAR" appears. Press the button "set" to enter.	
Parameter "CF9" appears. Press the button "set" to enter.	
Parameter "A1" appears. Use the buttons "down arrow" and "up arrow" to select "dEF" parameter.	
Press the button "set" to enter.	
The default value is "OFF". Use the buttons "down arrow" and "up arrow" to change from "OFF" to "On".	
Press the button "set" to confirm.	
After few seconds return to "OFF". The parameters were automatically reset. Press the button "esc" to exit, three time.	







Remote ON/OFF

Switch ON the chiller "ON" using the Main disconnect switch QS, and wait on display the indication "OFF". Press the buttons "esc" "set" together to enter on "U" parameters.	
Parameter "PAR" appears. Press the button "set" to enter.	
Parameter "CF9" appears. Press the button "set" to enter.	
Parameter "A1" appears. Use the buttons "down arrow" and "up arrow" to select "A7" parameter.	
Press the button "set" to enter.	
The default value is "0". Use the buttons "down arrow" and "up arrow" to select the mode: (par. 4.5.1- Tab.2)	
Press the button "set" to confirm.	
Automatically return to "A7". The parameter has now been stored. Press the button "esc" to exit, three time.	



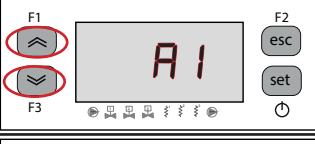



Tab.2 Remote On / Off mode (A7)

0	Remote On/Off disabled
1	Remote On/Off enabled together with local On/Off. In case of loss of power, or the main switch is turned off, then, on return of power the chiller must be restarted locally
2	Remote On/Off only, local On/Off disabled

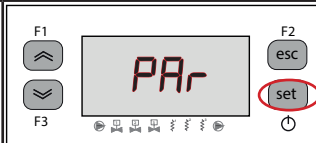
Software version

Switch ON the chiller "ON" using the Main disconnect switch QS, and wait on display the indication "OFF". Press the buttons "esc" "set" together to enter on "U" parameters.	
Parameter "PAR" appears. Press the button "set" to enter.	
Parameter "CF9" appears. Press the button "set" to enter.	
Parameter "A i" appears. Use the buttons "down arrow" and "up arrow" to select "UER" parameter.	
Press the button "set" to enter.	
The software version is shown	
Press the button "esc" to exit, three time.	

Supervisor enabling

Switch ON the chiller "ON" using the Main disconnect switch QS, and wait on display the indication "OFF". Press the buttons "esc" "set" together to enter on "U" parameters.	
Parameter "PAR" appears. Press the button "set" to enter.	
Parameter "CF9" appears. Press the button "set" to enter.	
Parameter "A i" appears. Use the buttons "down arrow" and "up arrow" to select "SUP" parameter.	
Press the button "set" to enter.	
The default value is "OFF" Use the buttons "down arrow" and "up arrow" to change.	
Press the button "set" to confirm.	
The parameter has now been stored. Press the button "esc" to exit, three time.	

Modbus (address)

Switch ON the chiller "ON" using the Main disconnect switch QS, and wait on display the indication "OFF". Press the buttons "esc" "set" together to enter on "U" parameters.	
Parameter "PAR" appears. Press the button "set" to enter.	
Parameter "CF9" appears. Press the button "set" to enter.	
Parameter "A1" appears. Use the buttons "down arrow" and "up arrow" to select "CF30" parameter.	
Press the button "set" to enter.	
The default value is "1" Use the buttons "down arrow" and "up arrow" to change the address.	
Press the button "set" to confirm.	
The parameter has now been stored. Press the button "esc" to exit, three time.	







Modbus (protocol)

Switch ON the chiller "ON" using the Main disconnect switch QS, and wait on display the indication "OFF". Press the buttons "esc" "set" together to enter on "U" parameters.	
Parameter "PAR" appears. Press the button "set" to enter.	
Parameter "CF9" appears. Press the button "set" to enter.	
Parameter "A1" appears. Use the buttons "down arrow" and "up arrow" to select "CF31" parameter.	
Press the button "set" to enter.	
The default value is "1" Use the buttons "down arrow" and "up arrow" to change the protocol. (par. 4.5.1- Tab.3)	
Press the button "set" to confirm.	
The parameter has now been stored. Press the button "esc" to exit, three time.	

Tab.3 Protocol modbus (opcional)(CF3 1)

1	EVEN	2	NONE	3	ODD
---	------	---	------	---	-----

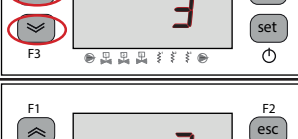
Modbus (baud rate)







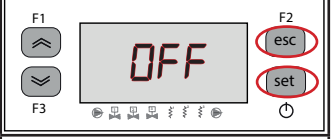

Switch ON the chiller "ON" using the Main disconnect switch QS, and wait on display the indication "OFF". Press the buttons "esc" "set" together to enter on "U" parameters.	
Parameter "PAR" appears. Press the button "set" to enter.	
Parameter "CF9" appears. Press the button "set" to enter.	
Parameter "A i" appears. Use the buttons "⏪" and "⏩" to select "CF32" parameter.	
Press the button "set" to enter.	
The default value is "3" Use the buttons "⏪" and "⏩" to change the baud rate. (par. 4.5.1- Tab.4)	
Press the button "set" to confirm.	
The parameter has now been stored. Press the button "esc" to exit, three time.	

Tab.4 Baud rate (optional)(CF32)

1	2400	3	9600	5	38400	7	115200
2	4800	4	19200	6	57600		

 **Note:** if you change the MODBUS parameters, to validate the new parameters you must turn OFF the chiller and then turn it back ON again.

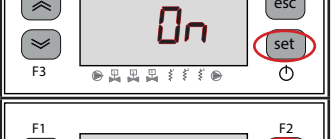
ERD enabling

Switch ON the chiller "ON" using the Main disconnect switch QS, and wait on display the indication "OFF". Press the buttons "esc" "set" together to enter on "U" parameters.	
Parameter "PAR" appears. Press the button "set" to enter.	
Parameter "CF9" appears. Press the button "set" to enter.	
Parameter "A i" appears. Use the buttons "⏪" and "⏩" to select "SUP" parameter.	
Press the button "set" to enter.	
The default value is "OFF" Use the buttons "⏪" and "⏩" to change.	
Press the button "set" to confirm.	
The parameter has now been stored. Press the button "esc" to exit, three time.	

 **With ERD parameter enable:** The water set temperature change on referring the ambient temperature. The function is only active if the temperature precision control is disabled (CPT=OFF).

4.6.2 Temperature control "CNP"

Temperature control setting

Switch ON the chiller "ON" using the Main disconnect switch QS, and wait on display the indication "OFF".

Press the buttons "esc" "set" together to enter on "U" parameters.



Parameter "PAR" appears.

Press the button "set" to enter.



Parameter "CF9" appears.

Use the buttons "⏴" and "⏵" to select "CNP" parameter.

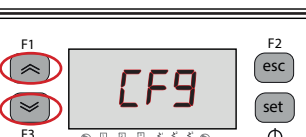

Press the button "set" to enter.



Parameter "SEt" appears.

Press the button "set" to enter.



The default value is "13.0"

Use the buttons "⏴" and "⏵" to change the value.



Press the button "set" to confirm.



The parameter has now been stored.

Press the button "esc" to exit, three time.



Important: A set of temperature between 1°C and 5°C, must be done by specialised technicians that must use the specific service manual of this product.

Temperature control differential setting

Switch ON the chiller "ON" using the Main disconnect switch QS, and wait on display the indication "OFF".

Press the buttons "esc" "set" together to enter on "U" parameters.



Parameter "PAR" appears.

Press the button "set" to enter.

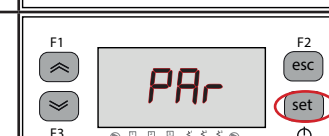

Parameter "CF9" appears.

Use the buttons "⏴" and "⏵" to select "CNP" parameter.

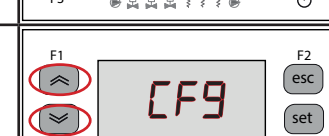

Press the button "set" to enter.



Parameter "SEt" appears.

Use the buttons "⏴" and "⏵" to select "d i F I" parameter.



Press the button "set" to enter.



The default value is "4.0"

Use the buttons "⏴" and "⏵" to change the value.



Press the button "set" to confirm.

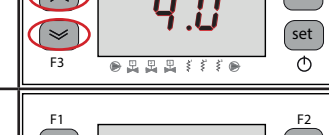

The parameter has now been stored.

Press the button "esc" to exit, three time.

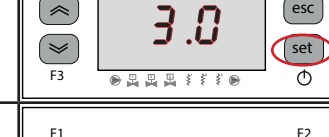

4.6.3 Probe parameter "bt 1"

Probe "bt 1".

Switch ON the chiller "ON" using the Main disconnect switch QS, and wait on display the indication "OFF".

Press the buttons "esc" "set" together to enter on "U" parameters.

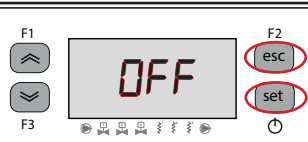

Parameter "PAR" appears.

Press the button "set" to enter.



Parameter "CF9" appears.

Use the buttons "⏏" and "⏪" to select "bt 1" parameter.



Press the button "set" to enter.



Parameter "HA 1" appears.

Press the button "set" to enter.



The default value is "60.0"

Use the buttons "⏏" and "⏪" to change the value.



Press the button "set" to confirm.



The parameter has now been stored.

Press the button "esc" to exit, three time.



Same sequence for probe "bt2".

4.7 Visualization of temperature probes

Chiller in operation.

Press the button "⏪" to see the probes
bt 1, bt 2, bt 3, bP 1



Select the probe and wait some seconds. (Es. BT2)

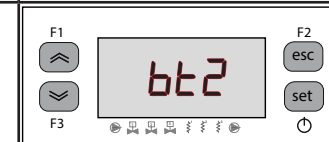

Value of the probe bt 2 appears.

























It is advisable to always return to probe bt 1



Probe	Description
bt 1	Water temperature
bt 2	Evaporator temperature
bt 3	Ambient temperature
bt 10	Electrical panel temperature
bP 1	Fan pressure

4.8 Setting clock/date

<p>Switch ON the chiller "ON" using the Main disconnect switch QS, and wait on display the indication "OFF".</p> <p>Press the buttons " " and " " together to enter on "Data/time" menu.</p>	
<p>Parameter "FrEE" appears.</p> <p>Press the button " " to enter.</p>	
<p>Parameter "R," appears.</p> <p>Use the buttons " " and " " to select "CL" parameter.</p>	
<p>Press the button " " to enter.</p>	
<p>Parameter "HOUr" appears.</p> <p>Press for 5 seconds the button " " .</p> <p>Now the parameter is flashing.</p>	
<p>Use the buttons " " and " " to select date, hour or year to change.</p>	
<p>Press the button " " to enter.</p>	
<p>Use the buttons " " and " " to change the value (es:year)</p>	
<p>Press the button " " to confirm.</p>	

Use the buttons " " and " " to change another value (es:date)



Press the button " " to exit.
The parameter stops flashing.



Press the buttons " " and " " together to exit.



⚠ The memory of the "clock / date" has a maximum duration of three days, so if the controller is left without power for more than three days, the data set hour / month / year are lost.
Adjust the clock at the start up of the machine, and whenever necessary.

4.9 Alarm management

In the presence of an alarm, alarm code appear and a symbol at the top left

 Continuous = alarm present
Flashing = warning present/ Alarm resettable

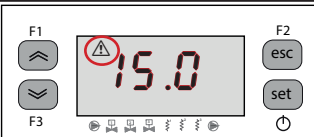

Press the button "set" to enter.

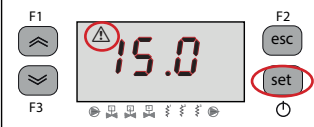

Parameter "RLH 1" appears.

Press the button "" to select "RL" parameter.



Press the button "set" to enter.



The code alarm appears as: "Er08".

Press the button "" to check if there are more alarms present.

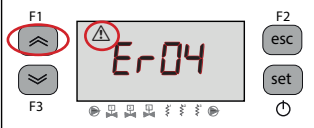

Repair the fault before performing the reset.

Once the fault has been repaired, the alarm symbol begins to flash.

Now you can perform the reset.

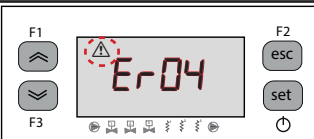



press the button "esc" until the alarm disappears.



Alarm/warning list

Code	Description	Action	Reset
Er01	Sensor bt1 cutout or broken	Alarm	A
Er02	Sensor bt2 cutout or broken	Alarm	A
Er03	Sensor bt3 cutout or broken	Alarm	A
Er05	Sensor bt10 cutout or broken	Alarm	A
Er06	Sensor bP1 cutout or broken	Alarm	A
Er08	High pressure circuit 1	Alarm	A
Er09	Low pressure circuit 1	Alarm	A
Er12	High temperature bt1	Alarm	A
Er13	Low temperature bt1	Alarm	A
Er14	High temperature bt2	Alarm	A
Er15	Low temperature bt2	Alarm	A
Er16	High temperature bt3	Alarm	A
Er17	Low temperature bt3	Alarm	A
Er18	Compressor thermal protection 1	Alarm	A
Er20	Pump thermal protection 1	Alarm	A
Er22	Low water level / Differential pressure switch	Alarm	A
Er23	Phase monitor	Alarm	A
Er24	Expansion broken or disconnected	Alarm	A
Er25	Exceeded compressor working hours	Warning	A
Er27	Exceeded unit working hours	Warning	A
Er28	Clock Memory	Warning	A
Er29	Chiller configuration	Warning	A

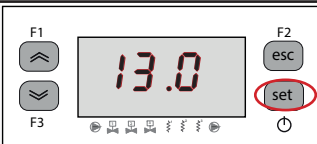
4.10 Alarm history

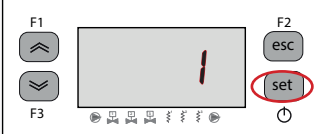
Chiller in operation. Press the button "set" to see the alarm history.	
Press the button "set" to enter.	
Use the buttons "⏪" and "⏩" to see the parameters. (Par. 4.5.5)	
Press the button "set" to see the value.	

5 Maintenance

• The machine is designed and built to guarantee continuous operation; however, the life of its components depends on the maintenance performed.

-  When requesting assistance or spare parts, identify the machine (model and serial number) by reading the dataplate located on the unit. (www.polewr.com.)

5.1 General instructions

- ⚠ Before performing any maintenance, make sure the power to the refrigerator is disconnected.
- 📖 Always use the Manufacturer's original spare parts: otherwise the Manufacturer is relieved of all liability regarding machine malfunctioning.
- 📖 In case of refrigerant leakage, contact qualified and authorized personnel.
- 📖 The Schrader valve must only be used in case of machine malfunction: otherwise any damage caused by incorrect refrigerant charging will not be covered by the warranty.a.

5.2 Refrigerant

















Charging: any damage caused by incorrect charging carried out by unauthorized personnel will not be covered by the warranty. 

- 📖 The equipment contains fluorinated greenhouse gases.
At normal temperature and pressure, the R513A refrigerant is a colourless gas classified in SAFETY GROUP A1 - EN378 (group 2 fluid according to Directive PED 2014/68/EU);
GWP (Global Warming Potential) = 573.

- ⚠ In case of refrigerant leakage, air the room.

5.3 Preventive Maintenance Programme

To guarantee lasting maximum chiller efficiency and reliability:

Maintenance Activity Description	Maintenance Interval (standard operating conditions)				
	Activity	Daily	6 Months	12 Months	36 Months
Check POWER ON indicator is lit.	Check 				
Check control panel indicators	Check 				
Clean condenser fins.	Service 				
Check electrical absorption	Check 				
Check refrigerant leaks	Service 				
Clean safety valve (if present)	Service 				
Check temperature sensors Replace if necessary	Service 				
Maintenance kit	Service 				



 The following are available (see par 7.):

- a) service kit:
- electrical kit;
 - compressor kit;
 - fan kit;
 - expansion valve kit;
 - evaporator kit;
 - pump kit
 - water tank kit;
- b) individual spare parts.

5.4 Dismantling

The refrigerant and the lubricating oil contained in the circuit must be recovered in conformity with current local environmental regulations.

The refrigerant fluid is recovered before final scrapping of the equipment ((EU) No. 517/2014 art.8).

	Recycling Disposal 
frame and panels	steel/epoxy resin polyester
tank	aluminium/copper/steel
pipes/collectors	copper/aluminium/carbon steel
pipe insulation	NBR rubber
compressor	steel/copper/aluminium/oil
condensator	steel/copper/aluminium
pump	steel/cast iron/brass
fan	aluminium
refrigerant	R513A
valve	brass/copper
electrical cable	copper/PVC

Equipment containing electrical components must be disposed separately collected with electrical and electronic waste according to local and currently legislation.



6 Troubleshooting

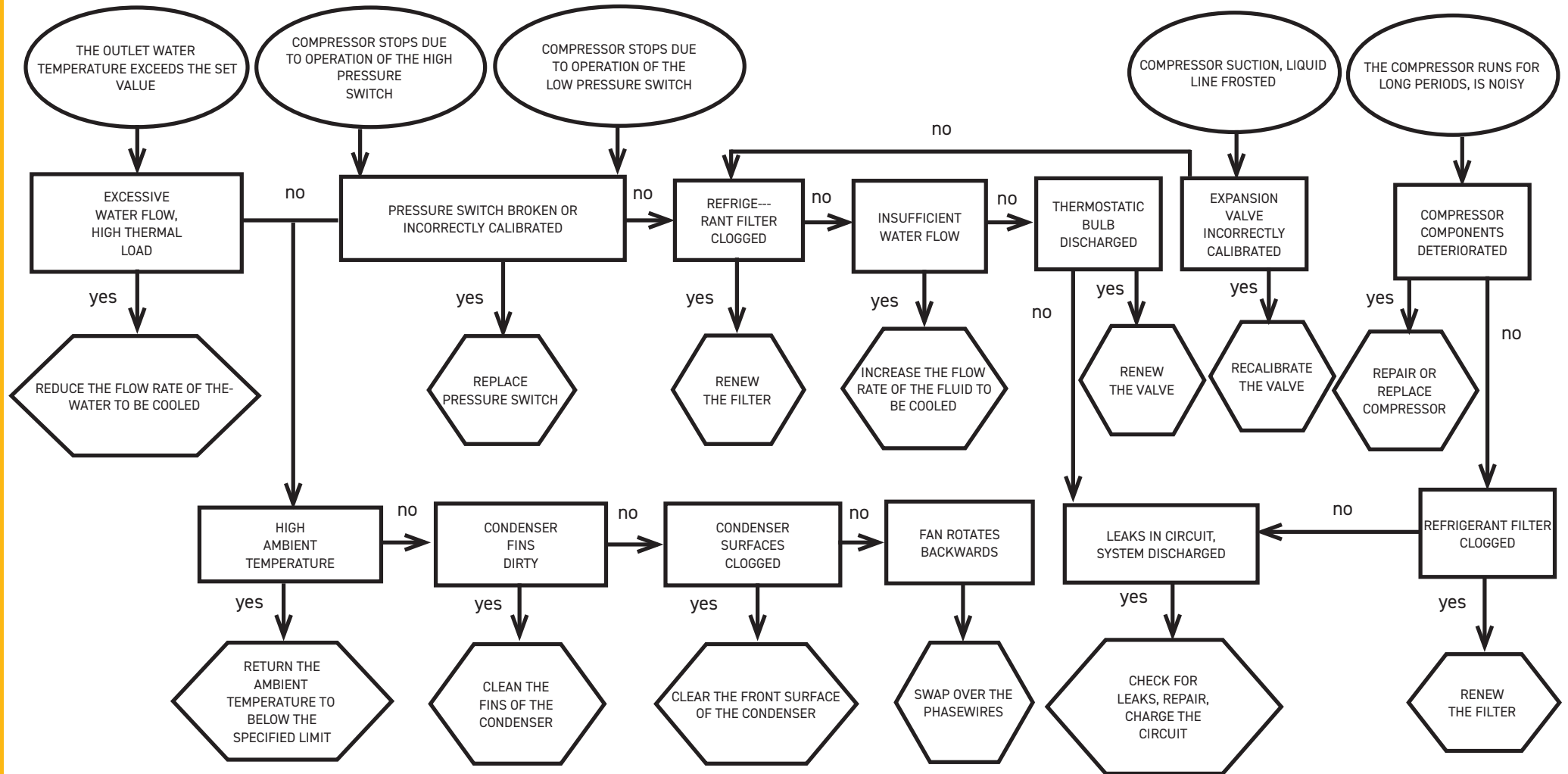

Índice

1 Seguridad	2	7 Apéndice
1.1 Importancia del manual.....	2	7.1 Leyenda
1.2 Señales de advertencia.....	2	7.2 Traslado
1.3 Instrucciones de seguridad.....	2	7.3 Espacio operativo
1.4 Riesgos residuales.....	2	7.4 Esquema de instalación
2 Introducción	3	7.5 Datos técnicos
2.1 Transporte.....	3	7.6 Dibujos de dimensiones
2.2 Traslado.....	3	7.7 Lista de repuestos
2.3 Inspección.....	3	7.8 Circuitos de refrigerante
2.4 Almacenaje.....	3	7.9 Esquema eléctrico
3 Instalación	3	
3.1 Espacio operativo.....	3	
3.2 Versiones.....	3	
3.3 Circuito hidráulico.....	3	
3.3.1 Controles y conexionado.....	3	
3.3.2 Agua y etilenglicol.....	4	
3.3.3 Vaso de expansión.....	4	
3.4 Circuito eléctrico.....	5	
3.4.1 Controles y conexionado.....	5	
3.4.2 Alarma general.....	5	
3.4.3 Encendido y apagado a distancia.....	5	
3.5 Versión por agua (W).....	5	
4 Control	6	
4.1 Panel de control.....	6	
4.2 Significado de los símbolos.....	6	
4.3 Encendido del enfriador.....	6	
4.3.1 Ajustes en la puesta en marcha.....	6	
4.4 Parada del enfriador.....	6	
4.5 Parameter settings.....	7	
4.5.1 Parámetros del enfriador (CF9).....	7	
4.5.2 Control de temperatura (CTP).....	7	
4.5.3 Parámetros de mantenimiento (Mnt).....	7	
4.5.4 Parámetros de la sonda (bE 1, bE 2).....	7	
4.5.5 Historial de alarmas (ALH i).....	7	
4.6 Cambiar parámetros (directo).....	8	
4.6.1 Parámetros del enfriador "CF9".....	8	
4.6.2 Control de temperatura "CTP".....	13	
4.6.3 Parámetro de sonda "bE 1".....	14	
4.7 Visualización de las sondas de temperatura (solo lectura).....	14	
4.8 Ajuste del reloj/calendario.....	15	
4.9 Gestión de alarmas.....	16	
4.10 Historial de alarmas.....	17	
5 Mantenimiento	17	
5.1 Advertencias generales.....	17	
5.2 Refrigerante.....	17	
5.3 Preventive Maintenance Programme.....	18	
5.4 Desguace.....	18	
6 Solución de problemas	19	

1 Seguridad

1.1 Importancia del manual

- Consérvelo durante toda la vida útil del equipo.
- Léalo antes de realizar cualquier operación.
- Puede sufrir modificaciones: para una información actualizada, consulte la versión instalada en el equipo.

1.2 Señales de advertencia



Instrucción para evitar peligros personales.



Instrucción para evitar que se dañe el equipo.





Se requiere la intervención de un técnico experto y autorizado.





El significado de los símbolos utilizados se indica en el apartado 7.

1.3 Instrucciones de seguridad

 Todas las unidades están provistas de un seccionador eléctrico que permite trabajar en condiciones de seguridad. Utilícelo siempre durante el mantenimiento.

 **El manual está destinado al usuario final y sólo para las operaciones que pueden realizarse con los paneles cerrados. Las operaciones de instalación/puesta en marcha/mantenimiento o que requieren la apertura con herramientas deben ser efectuadas por personal experto y calificado.**

 No supere los límites de proyecto que se indican en la placa de características.

  El usuario debe evitar cargas distintas de la presión estática interna. En caso de riesgo de fenómenos sísmicos, es necesario proteger adecuadamente la unidad. La unidad debe utilizarse exclusivamente para uso profesional y con el objeto para el cual ha sido diseñada.

 El usuario debe analizar todos los aspectos de la aplicación en que el producto se ha instalado, seguir todas las normas industriales de seguridad aplicables y todas las prescripciones relativas al producto descritas en el manual de uso y en la documentación redactada que se adjunta a la unidad. La alteración o sustitución de cualquier componente por parte del personal no autorizado, así como el uso inadecuado de la unidad eximen de toda responsabilidad al fabricante y provocan la anulación de la garantía.

El fabricante declina toda responsabilidad presente o futura por daños personales o materiales derivados de negligencia del personal, incumplimiento de las instrucciones dadas en este manual o

inobservancia de las normativas vigentes sobre la seguridad de la instalación.

El fabricante no asume ninguna responsabilidad por daños debidos a alteraciones y/o modificaciones del embalaje.

El usuario es responsable que las especificaciones suministradas para seleccionar la unidad o sus componentes y/o opciones sean exhaustivas para un uso correcto o razonablemente previsible de la misma unidad o de los componentes.

 **ATENCIÓN: El fabricante se reserva el derecho de modificar sin previo aviso la información de este manual. Para que la información resulte completa, se recomienda al usuario consultar el manual a pie de máquina.**

1.4 Riesgos residuales

Las operaciones de instalación, puesta en marcha, apagado y mantenimiento del equipo deben realizarse de total conformidad con lo indicado en la documentación técnica del equipo y de manera tal que no se genere ninguna situación de riesgo.

Los riesgos que no han podido eliminarse con recursos técnicos de diseño se indican en la tabla siguiente.

parte del equipo	riesgo residual	modo	precauciones
batería de intercambio térmico	pequeñas heridas cortantes	contacto	evitar el contacto, usar guantes de protección
rejilla del ventilador y ventilador	lesiones	introducción de objetos puntiagudos en la rejilla mientras el ventilador está funcionando	no introducir ni apoyar ningún objeto en la rejilla de los ventiladores
interior del equipo: compresor y tubo de salida	quemaduras	contacto	evitar el contacto, usar guantes de protección
interior del equipo: partes metálicas y cables eléctricos	intoxicación, electrocución, quemaduras graves	defecto de aislamiento de los cables de alimentación que llegan al cuadro eléctrico del equipo; partes metálicas en tensión	protección eléctrica adecuada de la línea de alimentación; conectar cuidadosamente a tierra las partes metálicas
exterior del equipo: zona circundante	intoxicación, quemaduras graves	incendio por cortocircuito o sobrecalentamiento de la línea de alimentación del cuadro eléctrico del equipo	sección de los cables y sistema de protección de la línea de alimentación eléctrica conformes a las normas vigentes

2 Introducción

Los motores del compresor, de la bomba y del ventilador están dotados de una protección térmica contra eventuales sobrecalentamientos.

2.1 Transporte

El equipo embalado debe mantenerse:

- posición vertical;
- protegido de los agentes atmosféricos;
- protegido de golpes.

2.2 Traslado

Utilice una carretilla elevadora con horquillas, adecuada para el peso del equipo, y evite todo tipo de golpes.

2.3 Inspección

- Conserve el equipo en un lugar limpio y protegido de la humedad y la intemperie;
- no apilar las unidades;
- seguir las instrucciones presentes en el embalaje.

2.4 Almacenaje

- Keep the unit packed in a clean place protected from damp and bad weather.
- Do not stack the units;
- Follow the instructions given on the package.

3 Instalación

 Para realizar correctamente la instalación, siga las instrucciones dadas en los apartados.7.

 El producto instalado debe estar adecuadamente protegido contra el riesgo de incendio (ref. EN378-3).

 **Se recomienda que todos los enfriadores incorporen un filtrado previo adecuado cerca de la entrada de agua/ aceite.**

Líquidos que pueden enfriarse

Sólo pueden enfriarse líquidos que sean compatibles con los materiales empleados.

Algunos de los líquidos usados **son agua o mezclas de agua y etilenglicol o propilenglicol / aceite**. No se deben enfriar líquidos inflamables.

Si los líquidos a refrigerar contienen sustancias peligrosas (como por ejemplo glicol etilénico/propilénico), hay que recoger el líquido derramado en una zona de fuga porque es perjudicial para el medio ambiente. En caso de vaciado del circuito hidráulico, hay que cumplir con las normas vigentes y evitar la liberación del líquido al medio ambiente.

3.1 Espacio operativo

 Deje un espacio libre de 1,5 m todo alrededor del equipo.

Dejar al menos 2 metros de espacio encima del refrigerador en los modelos de expulsión vertical del aire de condensación.

3.2 Versiones

Versión por aire: ventiladores axiales (A)

No cree situaciones que permitan la recirculación del aire de enfriamiento.

No obstruya las rejillas de ventilación.

En las versiones con ventiladores axiales, se desaconseja canalizar el aire agotado.s

3.3 Circuito hidráulico

3.3.1 Controles y conexionado

 Antes de conectar el enfriador y llenar el circuito, asegurarse de que los tubos estén limpios. De lo contrario, lavarlos cuidadosamente.

  **Si el circuito hidráulico es de tipo cerrado, bajo presión, una válvula de seguridad ajustada a: 6 bar.**

 Se recomienda instalar filtros de red en los tubos de entrada y salida del agua.

 Si el circuito hidráulico posee válvulas automáticas de corte, proteger la bomba con sistemas contra golpe de ariete.

 Si se vacía el circuito por paradas prolongadas, se recomienda añadir aceite lubricante en el rodete de la bomba para evitar su bloqueo en el arranque siguiente. En caso de bloqueo del rodete, desbloquéelo manualmente.

Quite la tapa posterior de la bomba y gire suavemente el ventilador de plástico. Si el eje siguiera bloqueado, quite el ventilador y actúe directamente en el eje. Una vez desbloqueado el rodete, vuelva a colocar el ventilador y la tapa.

Controles preliminares

1. Cerciorarse de que las válvulas de corte del circuito hidráulico estén abiertas.
2. Si el circuito hidráulico es cerrado, controlar que se haya instalado un vaso de expansión de capacidad adecuada.

Conexionado

1. Conectar el refrigerador de agua a los conductos de entrada y salida utilizando los correspondientes empalmes ubicados en la parte trasera de la unidad.
Se aconseja utilizar conexiones flexibles para quitar rigidez al sistema.
2. Llenar el circuito hidráulico utilizando la conexión de carga situada en la parte posterior del enfriador ().
3. El depósito está provisto de un purgador de aire que debe accionarse manualmente a la hora del llenado. Si el circuito hidráulico presenta puntos elevados, instalar una válvula de escape en ellos.
4. Se aconseja instalar válvulas de corte en la entrada y la salida del equipo para poder excluirlo del circuito en caso de mantenimiento.
5. Si el enfriador funciona con cuba abierta, la bomba se debe instalar en el tubo de admisión de la cuba y en el tubo de impulsión al enfriador.

 **Advertencia (modelos 022-120): la máquina está equipada con un dispositivo de protección automática para el tanque.**

Si la entrada de agua se cierra inadvertidamente cuando la bomba está funcionando y la salida de agua está abierta, el aire ingresará al tanque con la probable intervención del sensor de nivel. Será necesario ventilar el circuito hidráulico para eliminar el aire.

Controles sucesivos

1. Controlar que el depósito y el circuito estén completamente llenos de agua y que se haya purgado todo el aire.
2. El circuito hidráulico debe mantenerse siempre lleno. Para ello se debe controlar y rellenar periódicamente, o bien instalar un dispositivo de llenado automático.

Características del agua

Si el suministro no lo incluye, instale un filtro de malla en la entrada del agua.

 Características del agua:

Temperatura	>50°F (10°C)	CL ⁻	<50 ppm
ΔT IN/OUT	5-15°C	CaCO ₃	70-150 ppm
Max % de glicol	50	O ₂	<0.1 ppm
PH	7.5-9	Fe	<0.2 ppm
Conductividad eléctrica	10-500 μS/cm	NO ₃	<2 ppm
Índice de saturación de Langelier	0-1	HCO ₃ ⁻	70-300 ppm
SO ₄ ²⁻	<50 ppm	H ₂ S	<0.05 ppm
NH ₃	<1 ppm	CO ₂	<5 ppm
		Al	<0.2 ppm

Es posible que los materiales estándar previstos para el refrigerador no sean adecuados para determinadas aguas de refrigeración (desionizada, desmineralizada, destilada). En estos casos, se ruega ponerse en contacto con el fabricante.

3.3.2 Agua y etilenglicol

Si el equipo está instalado en el exterior, o en un local cubierto pero sin calefacción, durante las paradas en los meses más fríos el agua que está dentro del circuito se puede congelar.

Para evitarlo, es posible:

- dotar al enfriador de adecuadas protecciones antihielo suministradas como opcionales por el fabricante;
- descargar la instalación a través de la válvula correspondiente, en caso de paradas prolongadas;
- añadir un anticongelante al agua de circulación (ver tabla).

Temperatura agua de salida [°C]	Etilenglicol (% vol.)	Temperatura ambiente
4	5	-2
2	10	-5
0	15	-7
-2	20	-10
-4	25	-12
-6	30	-15
-10	40	-20

A veces, la temperatura de salida del agua exige el uso de etilenglicol para evitar la formación de hielo. Las proporciones adecuadas son.

3.3.3 Vaso de expansión

Para evitar que los aumentos o las disminuciones de volumen causados por las variaciones de temperatura dañen el equipo o el circuito, es conveniente instalar un vaso de expansión de capacidad adecuada.

El vaso de expansión se instala siempre en el lado de aspiración de la bomba.

El volumen mínimo del vaso de expansión que se debe aplicar a un circuito cerrado se calcula con la fórmula siguiente:

$$V = 2 \times V_{tot} \times (P_{t \text{ mín.}} - P_{t \text{ máx.}})$$

donde

V_{tot} = volumen total del circuito (en litros)

P t mín./máx. = peso específico a la temperatura mínima/máxima que puede alcanzar el agua [kg/dm³].

En la tabla siguiente se indican los pesos específicos en función de la temperatura y del porcentaje de glicol.

% de glicol	Temperatura [°C]						
	-10	0	10	20	30	40	50
0%	1.0024	1.0008	0.9988	0.9964	0.9936	0.9905	0.9869
10%	1.0177	1.0155	1.0130	1.0101	1.0067	1.0030	0.9989
20%	1.0330	1.0303	1.0272	1.0237	1.0199	1.0156	1.0110
30%	1.0483	1.0450	1.0414	1.0374	1.0330	1.0282	1.0230
40%	1.0636	1.0594	1.0525	1.0511	1.0461	1.0408	1.0350

 **Atención:** Durante el llenado, tomar como referencia los datos de carga también del depósito de expansión.

Si la temperatura del aire ambiente en la enfriadora es inferior a -10 °C, debe mover el tanque de expansión a un lugar protegido cerca del lado de retorno de agua de la enfriadora. La válvula de seguridad y la válvula de purga deben permanecer en el enfriador.

3.4 Circuito eléctrico

3.4.1 Controles y conexionado



Antes de realizar cualquier operación en las partes eléctricas, cerciorarse de que no circule corriente.

Todas las conexiones eléctricas deben realizarse de conformidad con las disposiciones vigentes en el lugar de instalación.

Controles iniciales

1. La tensión y la frecuencia de red deben tener los valores indicados en la chapa de datos del enfriador. La tensión de alimentación no debe salirse en ningún momento de las tolerancias indicadas en el esquema eléctrico, las cuales, salvo indicación diversa, son +/- 10% para la tensión y +/- 1% para la frecuencia.
2. La tensión debe ser simétrica (valores eficaces de las tensiones y ángulos de fase entre fases consecutivas iguales entre sí). El desequilibrio máximo admitido entre las tensiones es del 2%.

Conexionado

1. La alimentación eléctrica de los enfriadores se realiza con un cable de cuatro conductores (tres polos más tierra) sin neutro. Para la sección mínima del cable, vea el apartado 7.3.
2. Pasar el cable por el sujetacables situado en el panel posterior del equipo, conectar la fase y el neutro a los bornes del seccionador general (QS) y la tierra al borne correspondiente (PE).
3. Instalar en el origen del cable de alimentación una protección contra contactos directos no inferior a IP2X o IPXXB.
4. En la línea de alimentación eléctrica del enfriador debe haber un interruptor automático con diferencial de (RCCB - IDn = 0.3A), la capacidad máxima indicada en el esquema eléctrico de referencia y un poder de corte adecuado a la corriente de cortocircuito existente en el lugar de instalación. La corriente nominal "In" de dicho magnetotérmico debe ser igual a FLA y la curva de intervención de tipo D.
5. Valor máximo de la impedancia de red = 0,274 ohm.

Controles sucesivos

Comprobar que el equipo y los dispositivos auxiliares estén conectados a tierra y protegidos contra cortocircuitos y sobrecargas.



Una vez conectado el equipo, cuando se cierra el interruptor general de alimentación para energizarlo, la tensión en el circuito eléctrico alcanza valores peligrosos. ¡Se recomienda la máxima precaución!

3.4.2 Alarma general

Todos los enfriadores están dotados de indicación de alarma (véase el esquema eléctrico). La regleta tiene un contacto de conmutación libre donde puede conectarse una alarma centralizada exterior de tipo acústico, visual o incluida en un sistema lógico (por ejemplo un PLC).

3.4.3 Encendido y apagado a distancia

Todos los enfriadores pueden dotarse de un mando de arranque y parada a distancia (apartado 7.3).

- Para habilitar el rif remoto. n.16387

- Como variable de referencia ON/OFF rif.n.8996

Nota: no habilitar juntos "Sup" y "Re" .

Para la conexión del contacto ON-OFF a distancia, véase el esquema eléctrico (apartado 7.)

4 Control

4.1 Panel de control



Botón ARRIBA: púlselo para incrementar el valor de un parámetro editable seleccionado.

Botón ABAJO: púlselo para reducir el valor de un parámetro editable seleccionado.

Botón ESC: para salir sin guardar; volver al nivel anterior;
PULSADO DURANTE 5 s. RESTABLECER ALARMA.

Botón SET: para salir y guardar/confirmar el valor; ir al siguiente nivel; acceder al menú de ajustes; **PULSADO DURANTE 5 s. ENCENDER EL ENFRIADOR.**

4.2 Significado de los símbolos

Símbolo	Estado del símbolo	función	Símbolo	Estado del símbolo	función	
	Encendido	Compresor ACT		Encendido	Valor de temperatura	
	Destellante	Compresor en espera			Encendido	Valor de presión
	Apagado	Compresor DES				
	Encendido	Alarma presente		Encendido	Calentador de anticongelante ACT	
	Destellante	Advertencia o Alarma restablecible		Apagado	Calentador de anticongelante DES	
	Apagado	Sin alarma				
	Encendido	Bomba 1 ACT		Encendido	Calentador del cárter ACT Compresor 1	
	Apagado	Bomba 1 DES		Apagado	Calentador del cárter DES Compresor 1	
	Encendido	Bomba 2 ACT (no presente)		Encendido	Calentador del cárter ACT Compresor 2 (no presente)	
	Apagado	Bomba 2 DES (no presente)		Apagado	Calentador del cárter DES Compresor 2 (no presente)	

4.3 Encendido del enfriador

1. Conecte el suministro eléctrico a la máquina girando el interruptor aislado principal QS a ON.
2. Pulse el botón "set" para encenderla.
3. Ajuste la temperatura de que desee en el controlador. (párr. 4.5.1)

Monitor de fase

Si en la pantalla se visualiza "E-23", el usuario tiene que comprobar que se hayan cableado correctamente los bornes de entrada del interruptor-seccionador.

4.3.1 Ajustes en la puesta en marcha

1. Ajuste de temperatura, consulte el párrafo 4.5.
2. Regulación de la bomba

Verifique el correcto funcionamiento de la bomba con el manómetro (lectura de P1 y P0) y compruebe los valores de límite de presión (Pmáx. y Pmín.) que se indican en la placa de datos de la bomba.

P1 = presión con la bomba en ON
P0 = presión con la bomba en OFF
Pmín. < (P1-P0) < Pmáx.

- Ejemplo n°1.
Condiciones:
circuito cerrado, presión P0 = 2 bar
valores de la placa de datos de la bomba: Pmín. 1 bar/ Pmáx. 3 bar
ajuste la salida de la válvula para dar una presión de 3 bar < P1 < 5 bar

- Ejemplo n°2.
Condiciones:
circuito abierto, presión P0 = 0 bar
valores de la placa de datos de la bomba: Pmín. 1 bar/ Pmáx. 3 bar
ajuste la salida de la válvula para dar una presión de 1 bar < P1 < 3 bar
3. Verifique el correcto funcionamiento de la bomba de manera similar en condiciones de operación normales.
Compruebe también que el amperaje de la bomba esté en los límites indicados en la placa de datos.
4. Apague el enfriador y procesa a llenar el circuito hidráulico a la temperatura de "AJUSTE".
5. Compruebe que la temperatura del agua "tratada" no cae por debajo de 5 °C y que la temperatura ambiente en que funciona el circuito hidráulico no cae por debajo de 5 °C. Si la temperatura es demasiado baja, utilice una cantidad adecuada de glicol, como se explica en el párrafo 3.3.3.

ATENCIÓN! antes de encender la bomba del refrigerador, cierre la válvula de salida del agua (instalada por el cliente).

Mantenga siempre abierta la válvula de entrada (instalada por el cliente).

Al encender la bomba, abra lentamente la válvula de salida del agua del refrigerador y ajuste el caudal como se describe en el punto 4.3.1.

4.4 Parada del enfriador

Quando no necesite que el enfriador esté en funcionamiento, apáguelo como se indica: Pulse el botón "set" (5 Sec.) .

No apague el interruptor QS para que los dispositivos de protección anticongelación sigan recibiendo alimentación eléctrica.

4.5 Parameter settings

General

Hay dos niveles de protección para los parámetros:

- Directo User-(U): con acceso inmediato, **Cambiado por el usuario**.
- Protegido con contraseña Service (S): se requiere contraseña para acceder, **(no cambiar)**.

4.5.1 Parámetros del enfriador (CF9)

PARÁMETRO	CÓDIGO	TIPO	PREDE-TER.
Unidad de medida.	R1	U	OFF
Gestión del relé de alarma	CFJ1	U	0
Restablecer los parámetros predeterminados	DEF	U	OFF
Activación / desactivación remota	R7	U	0
Versión de software	UEr	U	1.7.0
Dirección de la unidad	CF30	U	1
Velocidad en baudios	CF31	U	3
Protocolo Modbus	CF32	U	1
Activación / desactivación del supervisor	SUP	U	OFF
Activación de punto de ajuste dinámico	ErD	U	OFF

4.5.2 Control de temperatura (CTP)

PARÁMETRO	CÓDIGO	TIPO	PREDE-TER.
Punto de ajuste del control de temperatura (estándar)	SEt	U	13.0
Diferencial de control de la temperatura (NO presente en la configuración "control de precisión")	dIF1	U	4.0

4.5.3 Parámetros de mantenimiento (Mnt)

PARÁMETRO	CÓDIGO	TIPO	PREDE-TER.
Horas de trabajo de la unidad	UH	U	-
Horas de trabajo de la unidad (X1000)	UHL	U	-
Horas de trabajo parciales de la unidad	UPH	U	-
Horas de trabajo parciales de la unidad (X1000)	UPHL	U	-
Horas de trabajo del compresor 1	CIH	U	-
Horas de trabajo del compresor 1 (x1000)	CIHL	U	-

4.5.4 Parámetros de la sonda (bt1, bt2)

Sonda (bt1)

PARÁMETRO	CÓDIGO	TIPO	PREDE-TER.
Alarma de alta temperatura (agua)	HR1	U	60

Sonda (bt2)

PARÁMETRO	CÓDIGO	TIPO	PREDE-TER.
Alarma de alta temperatura (agua)	HR2	U	60







4.5.5 Historial de alarmas (ALH1)

PARÁMETRO	CÓDIGO	TIPO	PREDE-TER.
Número de alarma	HYSP	U	-
Ver código de alarma	HYSC	U	-
Ver día y mes de la alarma	HYSD	U	-
Ver hora y minutos de la alarma	HYSE	U	-
Temperatura bt1 en el momento de la alarma	HY51	U	-
Temperatura bt2 en el momento de la alarma	HY52	U	-
Condiciones de ajuste en el momento de la alarma	HY53	U	-





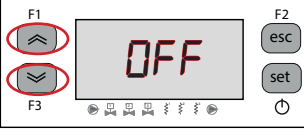



4.6 Cambiar parámetros (directo)

4.6.1 Parámetros del enfriador "CF9"

Unidad de medida.

Encienda el enfriador "ON" mediante el interruptor seccionador principal QS, y espere en la pantalla la indicación "OFF". Pulse a la vez los botones "esc" "set" para entrar en los parámetros "U".	
Aparece el parámetro "PAR". Pulse el botón "set" para entrar.	
Aparece el parámetro "CF9". Pulse el botón "set" para entrar.	
Aparece el parámetro "A1". Pulse el botón "set" para entrar	
El valor predeterminado es "OFF" = °C Utilice los botones "↵" y "⏶" para seleccionar la unidad de medida. OFF : temperatura = C°, Celsius ; presión = Bar; On : temperatura = °F, Fahrenheit; presión =PSI	
Pulse el botón "set" para confirmar.	
Volver automáticamente a "A1" El parámetro ha sido almacenado. Pulse el botón "esc" tres veces para salir.	

Gestión de alarmas

Encienda el enfriador "ON" mediante el interruptor seccionador principal QS, y espere en la pantalla la indicación "OFF". Pulse a la vez los botones "esc" "set" para entrar en los parámetros "U".	
Aparece el parámetro "PAR". Pulse el botón "set" para entrar.	
Aparece el parámetro "CF9". Pulse el botón "set" para entrar.	
Aparece el parámetro "A1". Utilice los botones "↵" y "⏶" para seleccionar el parámetro "CFJ1".	
Pulse el botón "set" para entrar.	
El valor predeterminado es "0" Utilice los botones "↵" y "⏶" para seleccionar la gestión del relé de alarma (par. 4.5.1- Tab.1)	
Pulse el botón "set" para confirmar.	
Volver automáticamente a "CFJ1" El parámetro ha sido almacenado. Pulse el botón "esc" tres veces para salir.	

Tab.1 Gestión del relé de alarma (CFJ1.)

0	Relé normalmente desactivado, excitado por una alarma.
1	Relé normalmente excitado (también con control OFF), desactivado por una alarma.
2	Relé normalmente excitado (solo con control ON), desactivado por una alarma o con control OFF.

Parámetros predeterminados

<p>Encienda el enfriador "ON" mediante el interruptor seccionador principal QS, y espere en la pantalla la indicación "OFF".</p> <p>Pulse a la vez los botones "esc" y "set" para entrar en los parámetros "U".</p>	
<p>Aparece el parámetro "PAR".</p> <p>Pulse el botón "set" para entrar.</p>	
<p>Aparece el parámetro "CF9".</p> <p>Pulse el botón "set" para entrar.</p>	
<p>Aparece el parámetro "A1".</p> <p>Utilice los botones "⏪" y "⏩" para seleccionar el parámetro "dEF".</p>	
<p>Pulse el botón "set" para entrar.</p>	
<p>El valor predeterminado es "OFF".</p> <p>Utilice los botones "⏪" y "⏩" para pasar de "OFF" a "On".</p>	
<p>Pulse el botón "set" para confirmar.</p>	
<p>Después de unos segundos vuelve a "OFF".</p> <p>Los parámetros se reajustaron automáticamente.</p> <p>Pulse el botón "esc" para uscir, tre volte.</p>	







ON/OFF remoto

<p>Encienda el enfriador "ON" mediante el interruptor seccionador principal QS, y espere en la pantalla la indicación "OFF".</p> <p>Pulse a la vez los botones "esc" y "set" para entrar en los parámetros "U".</p>	
<p>Aparece el parámetro "PAR".</p> <p>Pulse el botón "set" para entrar.</p>	
<p>Aparece el parámetro "CF9".</p> <p>Pulse el botón "set" para entrar.</p>	
<p>Aparece el parámetro "A1".</p> <p>Utilice los botones "⏪" y "⏩" para seleccionar el parámetro "A7".</p>	
<p>Pulse el botón "set" para entrar.</p>	
<p>El valor predeterminado es "0".</p> <p>Utilice los botones "⏪" y "⏩" para seleccionar el modo:</p> <p>(par. 4.5.1- Tab.2)</p>	
<p>Pulse el botón "set" para confirmar.</p>	
<p>Volver automáticamente a "A7".</p> <p>El parámetro ha sido almacenado.</p> <p>Pulse el botón "esc" tres veces para salir.</p>	









Tab.2 Modo remoto On / Off (A7)

0	On / Off remoto desactivado
1	On/Off remoto junto con On/Off local. En caso de pérdida de alimentación, o si se desconecta el interruptor principal, al recuperar la alimentación eléctrica el enfriador debe reiniciarse de forma local.
2	On/Off remoto solo, On/Off local desactivado

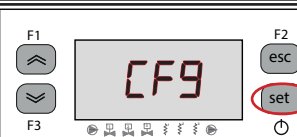
Versión del software (solo lectura)

<p>Encienda el enfriador "ON" mediante el interruptor seccionador principal QS, y espere en la pantalla la indicación "OFF".</p> <p>Pulse a la vez los botones "esc" "set" para entrar en los parámetros "U".</p>	
<p>Aparece el parámetro "PAR".</p> <p>Pulse el botón "set" para entrar.</p>	
<p>Aparece el parámetro "CF9".</p> <p>Pulse el botón "set" para entrar.</p>	
<p>Aparece el parámetro "A".</p> <p>Utilice los botones "⏪" y "⏩" para seleccionar el parámetro "UER".</p>	
<p>Pulse el botón "set" para entrar.</p>	
<p>Se muestra la versión del software</p>	
<p>Pulse el botón "esc" tres veces para salir.</p>	

Habilitación del supervisor

<p>Encienda el enfriador "ON" mediante el interruptor seccionador principal QS, y espere en la pantalla la indicación "OFF".</p> <p>Pulse a la vez los botones "esc" "set" para entrar en los parámetros "U".</p>	
<p>Aparece el parámetro "PAR".</p> <p>Pulse el botón "set" para entrar.</p>	
<p>Aparece el parámetro "CF9".</p> <p>Pulse el botón "set" para entrar.</p>	
<p>Aparece el parámetro "A".</p> <p>Utilice los botones "⏪" y "⏩" para seleccionar el parámetro "SUP".</p>	
<p>Pulse el botón "set" para entrar.</p>	
<p>El valor predeterminado es "OFF".</p> <p>Utilice los botones "⏪" y "⏩" para cambiar.</p>	
<p>Pulse el botón "set" para confirmar.</p>	
<p>El parámetro ha sido almacenado.</p> <p>Pulse el botón "esc" tres veces para salir.</p>	

Modbus (dirección)

Encienda el enfriador "ON" mediante el interruptor seccionador principal QS, y espere en la pantalla la indicación "OFF". Pulse a la vez los botones "esc" "set" para entrar en los parámetros "U".	
Aparece el parámetro "PAR". Pulse el botón "set" para entrar.	
Aparece el parámetro "CF9". Pulse el botón "set" para entrar.	
Aparece el parámetro "A1". Utilice los botones "set" y "esc" para seleccionar el parámetro "CF30".	
Pulse el botón "set" para entrar.	
El valor predeterminado es "1". Utilice los botones "set" y "esc" para cambiar la dirección.	
Pulse el botón "set" para confirmar.	
El parámetro ha sido almacenado. Pulse el botón "esc" tres veces para salir.	







Modbus (protocolo)

Encienda el enfriador "ON" mediante el interruptor seccionador principal QS, y espere en la pantalla la indicación "OFF". Pulse a la vez los botones "esc" "set" para entrar en los parámetros "U".	
Aparece el parámetro "PAR". Pulse el botón "set" para entrar.	
Aparece el parámetro "CF9". Pulse el botón "set" para entrar.	
Aparece el parámetro "A1". Utilice los botones "set" y "esc" para seleccionar el parámetro "CF31".	
Pulse el botón "set" para entrar.	
El valor predeterminado es "1". Utilice los botones "set" y "esc" para cambiar el protocolo. (par. 4.5.1- Tab.3)	
Pulse el botón "set" para confirmar.	
El parámetro ha sido almacenado. Pulse el botón "esc" tres veces para salir.	

Tab.3 Protocolo modbus (opcional) (CF3 1)

1	PAR	2	NINGUNO	3	IMPAR
---	-----	---	---------	---	-------

Modbus (velocidad en baudios)

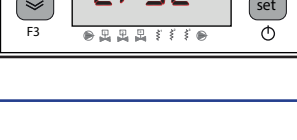







Encienda el enfriador "ON" mediante el interruptor seccionador principal QS, y espere en la pantalla la indicación "OFF". Pulse a la vez los botones "esc" y "set" para entrar en los parámetros "U".	
Aparece el parámetro "PAR". Pulse el botón "set" para entrar.	
Aparece el parámetro "CF9". Pulse el botón "set" para entrar.	
Aparece el parámetro "A1". Utilice los botones "↓" y "↑" para seleccionar el parámetro "CF32".	
Pulse el botón "set" para entrar.	
El valor predeterminado es "3". Utilice los botones "↓" y "↑" para modificar la velocidad en baudios. (par. 4.5.1- Tab.4)	
Pulse el botón "set" para confirmar.	
El parámetro ha sido almacenado. Pulse el botón "esc" tres veces para salir.	

Tab.4 Velocidad en baudios (opcional) (CF32)

1	2400	3	9600	5	38400	7	115200
2	4800	4	19200	6	57600		

 **Nota:** si modifica los parámetros de MODBUS, para validar los nuevos parámetros deberá apagar el enfriador y volverlo a encender.

Habilitación de ERD

Encienda el enfriador "ON" mediante el interruptor seccionador principal QS, y espere en la pantalla la indicación "OFF". Pulse a la vez los botones "esc" y "set" para entrar en los parámetros "U".	
Aparece el parámetro "PAR". Pulse el botón "set" para entrar.	
Aparece el parámetro "CF9". Pulse el botón "set" para entrar.	
Aparece el parámetro "A1". Utilice los botones "↓" y "↑" para seleccionar el parámetro "ERd".	
Pulse el botón "set" para entrar.	
El valor predeterminado es "OFF". Utilice los botones "↓" y "↑" para cambiar.	
Pulse el botón "set" para confirmar.	
El parámetro ha sido almacenado. Pulse el botón "esc" tres veces para salir.	

 **Con el parámetro ERD activado:** La temperatura de ajuste del agua cambia en función de la temperatura ambiente. La función solo está activa si el control de precisión de la temperatura está desactivado (CPT=OFF).

4.6.2 Control de temperatura "CNP"

Ajuste del control de temperatura

<p>Encienda el enfriador "ON" mediante el interruptor seccionador principal QS, y espere en la pantalla la indicación "OFF".</p> <p>Pulse a la vez los botones "esc" "set" para entrar en los parámetros "U".</p>	
<p>Aparece el parámetro "PAR".</p> <p>Pulse el botón "set" para entrar.</p>	
<p>Aparece el parámetro "CF9".</p> <p>Utilice los botones "⏪" y "⏩" para seleccionar el parámetro "CNP".</p>	
<p>Pulse el botón "set" para entrar.</p>	
<p>Aparece el parámetro "SEt".</p> <p>Pulse el botón "set" para entrar.</p>	
<p>El valor predeterminado es "13.0".</p> <p>Utilice los botones "⏪" y "⏩" para modificar el valor.</p>	
<p>Pulse el botón "set" para confirmar.</p>	
<p>El parámetro ha sido almacenado.</p> <p>Pulse el botón "esc" tres veces para salir.</p>	







Importante: Un ajuste de temperatura entre 1 °C y 5 °C, debe ser realizado por técnicos especializados que deben utilizar el manual de servicio específico de este producto.

Regulación de la temperatura diferencial

<p>Encienda el enfriador "ON" mediante el interruptor seccionador principal QS, y espere en la pantalla la indicación "OFF".</p> <p>Pulse a la vez los botones "esc" "set" para entrar en los parámetros "U".</p>	
<p>Aparece el parámetro "PAR".</p> <p>Pulse el botón "set" para entrar.</p>	
<p>Aparece el parámetro "CF9".</p> <p>Utilice los botones "⏪" y "⏩" para seleccionar el parámetro "CNP".</p>	
<p>Pulse el botón "set" para entrar.</p>	
<p>Aparece el parámetro "SEt".</p> <p>Utilice los botones "⏪" y "⏩" para seleccionar el parámetro "dIF1".</p>	
<p>Pulse el botón "set" para entrar.</p>	
<p>El valor predeterminado es "4.0".</p> <p>Utilice los botones "⏪" y "⏩" para modificar el valor.</p>	
<p>Pulse el botón "set" para confirmar.</p>	
<p>El parámetro ha sido almacenado.</p> <p>Pulse el botón "esc" tres veces para salir.</p>	

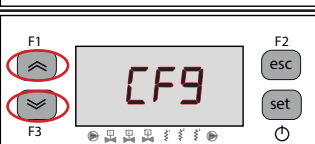
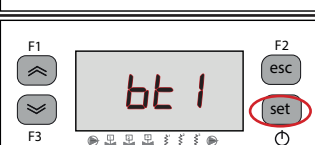

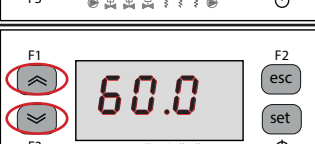
4.6.3 Parámetro de sonda "bt 1"

Sonda "bt 1".

Encienda el enfriador "ON" mediante el interruptor seccionador principal QS, y espere en la pantalla la indicación "OFF". Pulse a la vez los botones "esc" y "set" para entrar en los parámetros "U".	
Aparece el parámetro "PAr". Pulse el botón "set" para entrar.	
Aparece el parámetro "CF9". Utilice los botones "↓" y "↑" para seleccionar el parámetro "bt1".	
Pulse el botón "set" para entrar.	
Aparece el parámetro "HA 1". Pulse el botón "set" para entrar.	
El valor predeterminado es "60.0". Utilice los botones "↓" y "↑" para modificar el valor.	
Pulse el botón "set" para confirmar.	
El parámetro ha sido almacenado. Pulse el botón "esc" tres veces para salir.	



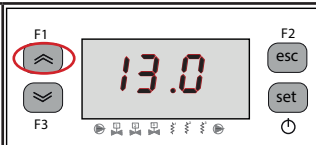

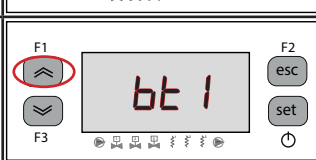



Misma secuencia para la sonda "bt2".

4.7 Visualización de las sondas de temperatura (solo lectura)

Enfriador en funcionamiento. Pulse el botón "↑" para ver las sondas <i>bt 1, bt 2, bt 3, bP 1</i> .	
Seleccione la sonda y espere unos segundos. (Es. BT2)	
Aparece el valor de la sonda <i>bt 2</i> .	
Es aconsejable volver siempre a la sonda <i>bt 1</i> .	

Sonda	Descripción
<i>bt 1</i>	Temperatura del agua
<i>bt 2</i>	Temperatura del evaporador
<i>bt 3</i>	Temperatura ambiente
<i>bt 10</i>	Temperatura del cuadro eléctrico
<i>bP 1</i>	Presión del ventilador 1

4.8 Ajuste del reloj/calendario

<p>Encienda el enfriador "ON" mediante el interruptor seccionador principal QS, y espere en la pantalla la indicación "OFF".</p> <p>Pulse a la vez los botones "⏪" y "⏩" para entrar en el menú "Datos/Hora".</p>	
<p>Aparece el parámetro "FrEE".</p> <p>Pulse el botón "set" para entrar.</p>	
<p>Aparece el parámetro "A".</p> <p>Utilice los botones "⏪" y "⏩" para seleccionar el parámetro "CL".</p>	
<p>Pulse el botón "set" para entrar.</p>	
<p>Aparece el parámetro "HOUr".</p> <p>Pulse durante 5 segundos el botón "set".</p> <p>Ahora el parámetro destella.</p>	
<p>Utilice los botones "⏪" y "⏩" para seleccionar la fecha, la hora o el año que desee cambiar.</p>	
<p>Pulse el botón "set" para entrar.</p>	
<p>Utilice los botones "⏪" y "⏩" para cambiar el valor (es:año)</p>	
<p>Pulse el botón "set" para confirmar.</p>	

Utilice los botones "⏪" y "⏩" para cambiar otro valor (es:fecha)



Pulse el botón "esc" para salir.
El parámetro deja de destellar.



Pulse ambos botones "⏪" y "⏩" para salir.



⚠ La memoria del "reloj / calendario" tiene una duración máxima de tres días, por lo que si el controlador no recibe alimentación eléctrica durante más de tres días, se perderán los datos de hora / mes / año.
Ajuste el reloj cuando empiece a utilizar el dispositivo y siempre que sea necesario.

4.9 Gestión de alarmas

En presencia de una alarma, aparecerá el código de alarma y un símbolo en la parte superior izquierda



Continuo = alarma presente

Intermitente = advertencia presente/ Alarma restablecible



Pulse el botón "set" para entrar.



Aparece el parámetro "ALH".

Pulse el botón "F1" para seleccionar el parámetro "AL".



Pulse el botón "set" para entrar.



El código de alarma que aparece es: "Er04".

Pulse el botón "F1" para comprobar si hay más alarmas presentes.

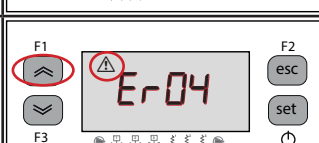

Repare el fallo antes de realizar el reinicio.

Una vez reparado el fallo, el símbolo de alarma comienza a destellar.

Ahora puede realizar el reinicio.

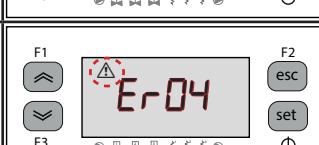

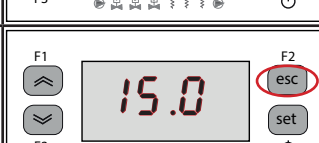

Pulse el botón "esc" hasta que desaparezca la alarma.



Lista de alarmas/avisos

Código	Descripción	Acción	Restab.
Er01	Sensor bt1 cortado o roto	Alarma	A
Er02	Sensor bt2 cortado o roto	Alarma	A
Er03	Sensor bt3 cortado o roto	Alarma	A
Er05	Sensor bt10 cortado o roto	Alarma	A
Er06	Sensor bP1 cortado o roto	Alarma	A
Er08	Circuito del presostato de alta presión 1	Alarma	A
Er09	Circuito del presostato de baja presión 1	Alarma	A
Er12	Alta temperatura bt1	Alarma	A
Er13	Baja temperatura bt1	Alarma	A
Er14	Alta temperatura bt2	Alarma	A
Er15	Baja temperatura bt2	Alarma	A
Er16	Alta temperatura bt3	Alarma	A
Er17	Baja temperatura bt3	Alarma	A
Er18	Protección térmica del compresor 1	Alarma	A
Er20	Protección térmica de la bomba 1	Alarma	A
Er22	Nivel de agua bajo / Presostato diferencial	Alarma	A
Er23	Monitor de fase	Alarma	A
Er24	Expansión rota o desconectada	Alarma	A
Er25	Horas de trabajo del compresor 1 excedidas	Advertencia	A
Er27	Horas de trabajo de la unidad excedidas	Advertencia	A
Er28	Memoria del reloj	Advertencia	A
Er29	Configuración del enfriador	Advertencia	A

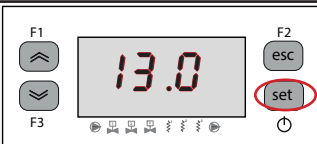
4.10 Historial de alarmas

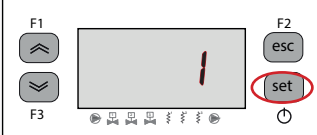
Enfriador en funcionamiento. Pulse el botón "set" para ver el historial de alarmas.	
Pulse el botón "set" para entrar.	
Utilice los botones "⏪" y "⏩" para ver los parámetros. (Par. 4.5.5)	
Pulse el botón "set" para ver el valor.	

5 Mantenimiento

• El equipo ha sido diseñado y realizado para funcionar de manera continua. No obstante, la duración de sus componentes depende directamente del mantenimiento que reciban.

-  Para solicitar asistencia o repuestos, comunique el modelo y el número de serie indicados en la placa de datos que está aplicada en el exterior del equipo. (www.polewr.com)

5.1 Advertencias generales

 Antes de efectuar cualquier operación de mantenimiento, controlar que se haya cortado la alimentación del refrigerador.

 El uso de repuestos no originales exime al fabricante de toda responsabilidad por el mal funcionamiento del equipo.

 En caso de pérdida de refrigerante, llame a un técnico experto y autorizado

 La válvula Schrader debe utilizarse sólo en caso de funcionamiento anómalo del equipo; de lo contrario, los daños causados por una carga incorrecta de refrigerante no serán reconocidos en garantía.

5.2 Refrigerante

Operación de carga: los daños causados por una carga incorrecta realizada por personal no autorizado no serán reconocidos en garantía. 











 El aparato contiene gases fluorados de efecto invernadero.

El fluido refrigerante R513A a temperatura y presión normales, es un gas incoloro perteneciente al SAFETY GROUP A1 - EN378 (fluido del grupo 2 según la directiva PED 2014/68/UE); GWP (Global Warming Potential) = 573.

 En caso de fuga de refrigerante, airee el local.

5.3 Preventive Maintenance Programme

To guarantee lasting maximum chiller efficiency and reliability:

Acciones de mantenimiento	Intervalo de tiempo (condiciones de funcionamiento estándar)			
	Diarias	6 Meses	12 Meses	36 Meses
Acciones comprobar  actuar 				
Comprobar que el indicador POWER ON está encendido.				
Comprobar todos los indicadores del panel de control.				
Limpiar el condensador, rejilla y conexiones.				
Comprobar el consumo eléctrico.				
Comprobar las pérdidas de refrigerante.				
Limpiar las Válvula de seguridad (si está presente)				
Comprobar las sondas de temperatura. Sustituir si fuera necesario.				 
Conjunto de mantenimiento				

 Están disponibles (apartado 7.):

a) kit de servicio:

- kit eléctrico;
- kit compresor;
- kit ventilador;
- kit válvula de expansión;
- kit evaporador;
- kit bomba;
- kit depósito de agua;

b) piezas de repuesto individuales.

5.4 Desguace

El fluido refrigerante y el aceite lubricante contenidos en el circuito deben recogerse de conformidad con las normas locales.

El líquido refrigerante se debe recuperar antes de la destrucción definitiva del equipo ((UE) N° 517/2014 art.8).

	RECICLAJE DESMANTELAMIENTO 
carpintería	acero/resinas epóxicas, poliéster
depósito	aluminio/cobre/acero
tubos/colectores	cobre/aluminio/acero de carbono
aislamiento de los tubos	caucho nitrílico (NBR)
compresor	acero/cobre/aluminio/aceite
condensador	acero/cobre/aluminio
bomba	acero/fundición/latón
ventilador	aluminio
refrigerante	R513A
válvulas	latón/cobre
cables eléctricos	cobre/PVC

Los equipos que contengan componentes eléctricos deben eliminarse por separado junto con los residuos eléctricos y electrónicos de acuerdo con la legislación local y vigente.



6 Solución de problemas

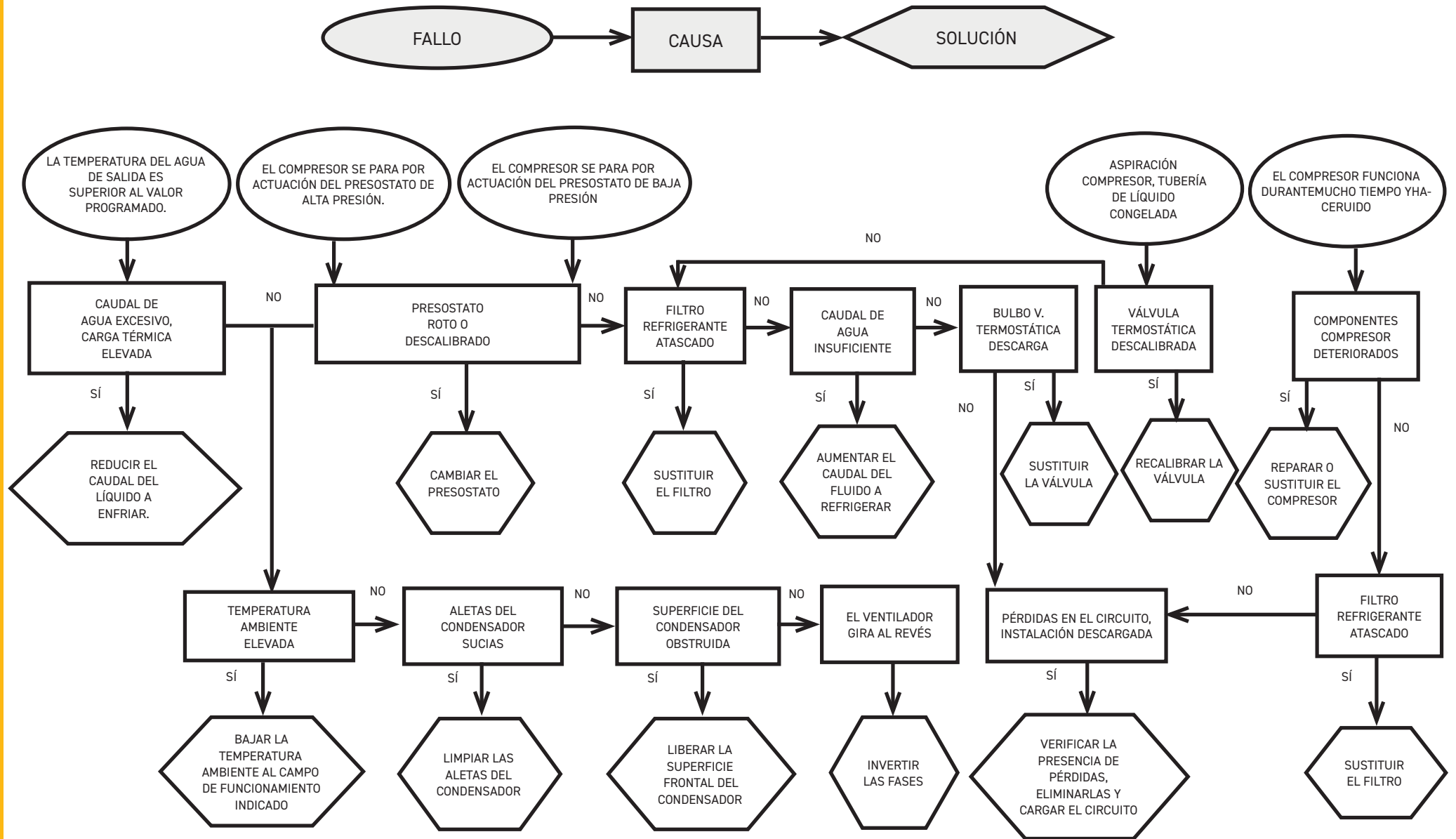

Sommaire

1 Sécurité	2	7 Appendix
1.1 Importance de la notice.....	2	7.1 Légende
1.2 Signaux d'avertissement.....	2	7.2 Manutention
1.3 Consignes de sécurité.....	2	7.3 Espace de travail
1.4 Risques résiduels.....	2	7.4 Schéma d'installation
2 Introduction	3	7.5 Caractéristiques techniques
2.1 Transport.....	3	7.6 Dimensions
2.2 Manutention.....	3	7.7 Liste des pièces de rechange
2.3 Inspection ou visite.....	3	7.8 Schéma du circuit
2.4 Stockage.....	3	7.9 Schéma électrique
3 Installation	3	
3.1 Espace de travail.....	3	
3.2 Versions.....	3	
3.3 Circuit hydraulique.....	3	
3.3.1 Contrôles et raccordement.....	3	
3.3.2 Eau et glycol éthylénique.....	4	
3.3.3 Vase d'expansion.....	4	
3.4 Circuit électrique.....	5	
3.4.1 Contrôles et branchements.....	5	
3.4.2 Alarme générale.....	5	
3.4.3 ON/OFF à distance.....	5	
3.5 Version condensation à eau (W).....	5	
4 Commande	6	
4.1 Tableau de commande.....	6	
4.2 Signification des symboles.....	6	
4.3 Démarrage du refroidisseur.....	6	
4.3.1 Réglages à la mise en service.....	6	
4.4 Arrêt du refroidisseur.....	6	
4.5 Réglages des paramètres.....	7	
4.5.1 Paramètres du refroidisseur (CF9).....	7	
4.5.2 Contrôle de la température (CIP).....	7	
4.5.3 Paramètres de maintenance (Pnt).....	7	
4.5.4 Paramètres de la sonde (bt 1, bt 2).....	7	
4.5.5 Historique des alarmes (RLH).....	7	
4.6 Modification des paramètres (direct).....	8	
4.6.1 Paramètres du refroidisseur (CF9).....	8	
4.6.2 Contrôle de la température « CIP ».....	13	
4.6.3 Paramètre sonde « bt 1 ».....	14	
4.7 Visualisation des sondes de température (en lecture seule).....	14	
4.8 Réglage de l'heure/la date.....	15	
4.9 Gestion des alarmes.....	16	
4.10 Historique des alarmes.....	17	
5 Entretien	17	
5.1 Recommandations générales.....	17	
5.2 Réfrigérant.....	17	
5.3 Entretien préventif ou prédictif.....	18	
5.4 Mise au rebut.....	18	
6 Dépannage	19	

1 Sécurité

1.1 Importance de la notice

- La notice doit être conservée pendant toute la durée de vie de la machine.
- Lire la notice avant toute opération ou intervention.
- La notice est sujette à modifications : pour une information actualisée, consulter la version à bord de la machine.

1.2 Signaux d'avertissement



Instructions pour éviter de faire courir des risques aux personnes.



Instructions à suivre pour éviter de faire subir des dégâts à l'appareil.





La présence d'un professionnel qualifié et agréé est exigée.





Sont présents des symboles dont la signification est donnée au paragraphe 7.

1.3 Consignes de sécurité

 Chaque unité est munie d'un sectionneur électrique pour permettre toute intervention en conditions de sécurité. Toujours actionner ce dispositif pour éliminer les risques pendant les opérations d'entretien.

 **La notice s'adresse à l'utilisateur final uniquement pour les opérations pouvant être effectuées panneaux fermés ; par contre, les opérations de installation/la mise en service/entretien o qui nécessitent l'ouverture avec des outils doivent être confiées à un professionnel expert et qualifié.**

 Ne pas dépasser les limites définies par le projet, qui sont indiquées sur la plaque des caractéristiques.

  Il incombe à l'utilisateur d'éviter des charges différentes de la pression statique interne. En cas de risque d'activité sismique, l'unité doit être convenablement protégée. N'utiliser l'unité que pour un usage professionnel et pour la destination prévue par le constructeur.

 Il incombe à l'utilisateur d'analyser tous les aspects de l'application pour laquelle l'unité est installée, de suivre toutes les consignes industrielles de sécurité applicables et toutes les prescriptions inhérentes au produit contenues dans le manuel d'utilisation et dans tout autre documentation réalisée et fournie avec l'unité.

La modification ou l'adaptation ou le remplacement d'un composant quelconque par une personne non autorisée et/ou l'usage impropre de l'unité dégagent le constructeur de toute responsabilité et comportent l'annulation de la garantie.

Le constructeur ne saurait être tenu pour responsable pour tous les dommages matériels aux choses ou à l'unité et pour tous les dommages physiques aux personnes dérivant d'une négligence des opérateurs, du non-respect de toutes les instructions de la présente notice, de l'inapplication des normes en vigueur concernant la sécurité de l'installation.

La responsabilité du constructeur est dérogée pour tous les dommages ou dégâts éventuels pouvant résulter de manipulations malveillantes et/ou de modifications de l'emballage.

L'utilisateur doit s'assurer que les conditions fournies pour la sélection de l'unité ou de ses composants et/ou options sont parfaitement conformes pour une utilisation correcte de cette même unité ou de ses composants.

 **ATTENTION: Le fabricant se réserve le droit de modifier sans aucun préavis les informations contenues dans ce manuel. Afin de disposer d'informations complètes et actualisées, il est recommandé à l'utilisateur de consulter le fabricant.**

1.4 Risques résiduels

L'installation, la mise en marche, l'arrêt et l'entretien de la machine doivent être effectués conformément aux dispositions prévues par la documentation technique du produit et, quoiqu'il en soit, de manière à ne créer aucune situation de risque.

Les risques n'ayant pu être éliminés en phase de conception sont indiqués dans le tableau suivant.

partie concernée	risque résiduel	modalité	précautions
batterie d'échange thermique	petites coupures	contact	éviter tout contact, porter des gants de protection
grille ventilateur et ventilateur	lésions	introduction d'objets pointus à travers la grille lors du fonctionnement du ventilateur	n'introduire aucune sorte d'objets dans la grille des ventilateurs et ne poser aucun objet sur les grilles
partie interne de l'unité : compresseur et tuyau de refoulement	brûlures	contact	éviter tout contact, porter des gants de protection
partie interne de l'unité : parties métalliques et câbles électriques	intoxications, électrocution, brûlures graves	défaut d'isolation des câbles d'alimentation en amont du tableau électrique de l'unité, parties métalliques sous tension	protection électrique appropriée de la ligne d'alimentation ; faire très attention lors de la connexion à la terre des parties métalliques
partie externe de l'unité : zone environnante de l'unité	intoxications, brûlures graves	incendie dû à un court-circuit ou une surchauffe de la ligne d'alimentation en amont du tableau électrique de l'unité	section des câbles et système de protection de la ligne d'alimentation électrique conformes aux normes en vigueur

2 Introduction

Les moteurs du compresseur, de la pompe et du ventilateur sont protégés contre d'éventuelles surchauffes.

2.1 Transport

L'unité emballée doit rester

- en position verticale ;
- à l'abri des intempéries ;
- à l'abri des chocs.

2.2 Manutention

Utiliser un chariot élévateur d'une capacité suffisante à soulever le poids de la machine. Éviter tous chocs pendant la manutention.

2.3 Inspection ou visite

- Toutes les unités sont assemblées, câblées, chargées de réfrigérant et d'huile et testées en usine ;
- après réception de la machine, l'examiner soigneusement pour vérifier son état : recourir contre le transporteur pour les dommages éventuellement survenus au cours du transport ;
- débaler l'unité le plus près possible de son lieu d'implantation.

2.4 Stockage

- Conserver l'unité dans son emballage en un lieu propre et à l'abri de l'humidité et des intempéries.
- ne pas superposer les unités ;
- suivre les instructions sur l'emballage.

3 Installation

 Pour une installation optimale, suivre scrupuleusement les indications des paragraphes 7.

 Le produit installé doit être convenablement protégé contre les risques d'incendie (réf. EN378-3).

 **Il est recommandé d'équiper tous les refroidisseurs de systèmes de pré-filtrage à proximité de l'entrée d'eau des refroidisseurs.**

 **Liquides à refroidir**

Les liquides à refroidir doivent être compatibles avec les matériaux utilisés.

Exemples de liquides utilisés: de l'eau **ou des mélanges d'eau et de glycole éthylène ou propylène.**

Les liquides à refroidir ne doivent pas être inflammables.

Si les liquides à refroidir contiennent des substances dangereuses (glycol de la série éthylénique/propylénique, par exemple), toute fuite éventuelle doit être recueillie dans un récipient approprié, car potentiellement nuisible à l'environnement. En cas de vidange du circuit hydraulique, respecter la loi antipollution qui interdit le rejet des huiles usagées à l'égout ou dans la nature.

3.1 Espace de travail

 Prévoir un espace de dégagement de 1,5 m autour de l'unité.

Laisser au moins 2 mètres d'espace au-dessus de la centrale sur les modèles à expulsion verticale de l'air de condensation.

3.2 Versions

Version à air: Ventilateurs axiaux (A)

Ne pas créer des situations de recyclage de l'air de refroidissement.

Ne pas obstruer les grilles de ventilation.

Pour les versions avec ventilateurs axiaux, il est déconseillé de canaliser l'air épuisé.

3.3 Circuit hydraulique

3.3.1 Contrôles et raccordement

 Avant de raccorder le refroidisseur et de remplir le circuit, s'assurer que les tuyaux sont propres. Dans le cas contraire, laver soigneusement.

  **Si le circuit hydraulique est de type fermé, sous pression, une soupape de sécurité réglée à : 6 bar.**

 Il est conseillé de toujours installer des filtres grillagés sur les tuyauteries d'entrée et de sortie de l'eau.

 Si le circuit hydraulique est intercepté par des soupapes automatiques, protéger la pompe avec des systèmes contre les coups de bélier.

 Si le circuit est vidé pour inutilisation prolongée, ajouter du fluide lubrifiant sur le rotor de la pompe pour éviter le blocage au démarrage suivant. En cas de blocage du rotor débloquer manuellement.

Déposer le couvercle arrière de la pompe et tourner délicatement le ventilateur en plastique. Si l'arbre est encore bloqué, déposer le ventilateur et actionner directement l'arbre. Une fois le rotor débloqué, remettre en place le ventilateur et le couvercle.

Contrôles préliminaires

1. Contrôler que les éventuels robinets d'arrêt du circuit hydraulique sont ouverts.
2. Si le circuit hydraulique est de type fermé (seulement pour , contrôler que la capacité du vase d'expansion installé est adéquate.

Raccordement

1. Raccorder le réfrigérateur d'eau aux tuyaux d'arrivée et de sortie, en utilisant les raccords positionnés dans la partie postérieure de l'unité.
Il est conseillé d'utiliser des joints flexibles pour éliminer la rigidité du système.
2. Remplir le circuit hydraulique en utilisant le raccord de charge spécifique positionné à l'arrière du refroidisseur ().
3. Le réservoir est doté d'une soupape de décharge à actionner manuellement lors du remplissage.
A ce propos, si le circuit hydraulique présente des points à une hauteur supérieure, installer une soupape d'évent à ces endroits.
4. Il est conseillé de doter les tuyauteries d'entrée et de sortie d'un robinet, de manière à pouvoir exclure la machine du circuit en cas d'entretien nécessaire.
5. Si le refroidisseur fonctionne avec la cuve ouverte, la pompe doit être installée en aspiration à la cuve et en refoulement au refroidisseur.

 **Attention (modèles 022-120): la machine est équipée d'un dispositif de protection automatique pour le réservoir.**

Si l'entrée d'eau est fermée par inadvertance lorsque la pompe fonctionne et que la sortie d'eau est ouverte, de l'air pénétrera dans le réservoir avec l'intervention probable du capteur de niveau. Il sera

nécessaire de purger le circuit hydraulique pour éliminer l'air.

Contrôles successifs

1. Contrôler que tout l'air a bien été évacué du réservoir et du circuit et que ces derniers sont pleins d'eau.
2. Le circuit hydraulique doit être toujours rempli. Pour ce faire, il est possible de contrôler et de remettre à niveau périodiquement ou bien de doter l'installation d'un kit de remplissage automatique.

Caractéristiques de l'eau

Si la fourniture ne le prévoit pas, monter une crépine sur l'entrée de l'eau.

 Caractéristiques de l'eau:

Température	>50°F (10°C)	CL-	<50 ppm
ΔT IN/OUT	5-15°C	CaCO ₃	70-150 ppm
Max % glycole	50	O ₂	<0.1 ppm
PH	7.5-9	Fe	<0.2 ppm
Conductivité électrique	10-500 μS/cm	NO ₃	<2 ppm
Indice de saturation de Langelier	0-1	HCO ₃ ⁻	70-300 ppm
SO ₄ ²⁻	<50 ppm	H ₂ S	<0.05 ppm
NH ₃	<1 ppm	CO ₂	<5 ppm
		Al	<0.2 ppm

Pour des eaux spéciales (déionisée, déminéralisée, distillée) les matériaux standard prévus pour le réfrigérateur d'eau pourraient ne pas être appropriés. Dans ce cas, veuillez contacter le constructeur.

3.3.2 Eau et glycol éthylénique

Si l'unité est installée en plein air ou, quoiqu'il en soit, dans un endroit fermé non chauffé, il se peut qu'au cours de ses périodes d'inactivité, correspondant aux moments les plus froids de l'année, l'eau du circuit gèle

Pour éviter ce danger, il est possible : To avoid this hazard:

- de doter le refroidisseur de protections antigèle adéquates fournies en option par le constructeur ;
- de vidanger l'installation au moyen de la soupape de décharge en cas d'arrêts prolongés ;
- d'ajouter une quantité adéquate d'antigel à l'eau de circulation (voir tableau).

Température de l'eau en sortie [°C]	Glycol éthylénique (% vol.)	Température ambiante
4	5	-2
2	10	-5
0	15	-7
-2	20	-10
-4	25	-12
-6	30	-15
-10	40	-20

La température de l'eau en sortie atteint parfois un niveau tel qu'il faut mélanger cette dernière, selon les pourcentages indiqués ci-après, à du glycol éthylénique afin d'éviter toute formation de glace.

3.3.3 Vase d'expansion

Pour éviter que les augmentations ou les diminutions de volume du fluide, dues à une variation sensible de sa température, n'endommagent la machine ou le circuit, il est conseillé d'installer un vase d'expansion d'une capacité adéquate.

Le vase d'expansion doit être installé en aspiration sur la pompe sur le raccord postérieur du réservoir.

Pour calculer le volume minimal du vase d'expansion à appliquer à un circuit fermé, il est possible d'utiliser la formule suivante :

$$V=2 \times V_{tot} \times (P_{t \text{ min}} - P_{t \text{ max}})$$

où

V_{tot}= vol. total du circuit (en litres)

P_{t min/max}= poids spécifique à la température minimale/maximale que l'eau peut atteindre [kg/dm³].

Les valeurs de poids spécifique en fonction de la température et du pourcentage de glycol sont indiquées dans le tableau suivant:

% glycol	Température [°C]						
	-10	0	10	20	30	40	50
0%	1.0024	1.0008	0.9988	0.9964	0.9936	0.9905	0.9869
10%	1.0177	1.0155	1.0130	1.0101	1.0067	1.0030	0.9989
20%	1.0330	1.0303	1.0272	1.0237	1.0199	1.0156	1.0110
30%	1.0483	1.0450	1.0414	1.0374	1.0330	1.0282	1.0230
40%	1.0636	1.0594	1.0525	1.0511	1.0461	1.0408	1.0350

 **Attention : pendant le remplissage, se référer aux données de chargement pour le vase d'expansion.**

Si la température de l'air ambiant au niveau du refroidisseur est inférieure à -10 °C, vous devez déplacer le vase d'expansion vers une enceinte protégée du côté retour d'eau du refroidisseur. La soupape de sécurité et la soupape de purge doivent rester sur le refroidisseur.

3.4 Circuit électrique

3.4.1 Contrôles et branchements



Avant d'effectuer toute opération sur des parties électriques, s'assurer qu'elles ne sont pas sous tension.

Tous les branchements électriques doivent être conformes aux prescriptions locales du lieu d'installation.

Contrôles initiaux

1. La tension et la fréquence de réseau doivent correspondre aux valeurs estampillées sur la plaquette des données du refroidisseur. La tension d'alimentation ne doit pas, ne serait-ce que pour de courts instants, dépasser les limites de tolérance indiquées sur le schéma électrique qui, sous réserve d'indications différentes, équivalent à +/- 10% la tension et à +/- 1% pour la fréquence.
2. La tension doit être symétrique (valeurs efficaces des tensions et des angles de phase entre phases consécutives égales). Le déséquilibre maximal admis entre les tensions est de 2%.

Raccordement

1. L'alimentation électrique des refroidisseurs est effectuée au moyen d'un câble à 3 fils, 2 pôles+terre. Pour la section minimale du câble, voir paragraphe 7.
2. Passer le câble à travers le serre-câble situé sur le panneau postérieur de la machine et connecter la phase et le neutre aux bornes du sectionneur général (QS), la terre doit être connectée à la borne de terre prévue à cet effet (PE).
3. Assurer au commencement du câble d'alimentation une protection contre les contacts directs équivalant à au moins IP2Xo IPXXB.
4. Installer, sur la ligne d'alimentation électrique du refroidisseur, un interrupteur automatique avec différentiel (RCCB - IDn = 0.3A), de la portée maximale indiquée sur le schéma électrique de référence, avec un pouvoir d'interruption approprié au courant de court-circuit existant dans la zone d'installation de la machine.
Le courant nominal «In» de ce disjoncteur magnéto-thermique doit être égal à FLA et la courbe de déclenchement de type D.
5. Valeur maximum de l'impédance du réseau = 0.274 ohm.

Contrôles successifs

S'assurer que la machine et les équipements auxiliaires sont bien mis à la terre et qu'ils sont protégés contre les courts-circuits et/ou les surcharges.



Après avoir branché l'unité et fermé l'interrupteur général en amont (mettant ainsi la machine sous tension), le voltage atteint dans le circuit électrique des valeurs dangereuses. Faire très attention !

3.4.2 Alarme générale

Tous les refroidisseurs sont dotés d'un dispositif de signalisation d'alarme de la machine (voir le schéma électrique), composé d'un contact libre inverseur indiqué sur la boîte à bornes, ce qui permet de connecter une alarme centralisée externe, sonore, visuelle ou introduite dans des logiques, PLC par exemple.

3.4.3 ON/OFF à distance

Tous les refroidisseurs peuvent être dotés d'une commande de mise en marche et d'arrêt à distance (voir paragraphe 7.).

- Pour activer le rif à distance. n.16387

- Comme variable de référence ON/OFF rif.n.8996

Remarque : n'activez pas ensemble « Sup » et « Re ».

Pour le raccordement du contact ON-OFF à distance voir le schéma électrique (voir paragraphe 7.)

4 Commande

4.1 Tableau de commande



Touche flèche vers le haut : appuyer pour augmenter la valeur du paramètre modifiable sélectionné.



Touche flèche vers le bas : appuyer pour diminuer la valeur du paramètre modifiable sélectionné.



Touche ESC : pour quitter sans enregistrer ; revenir au niveau précédent.

EN APPUYANT PENDANT 5s. ON RÉINITIALISE L'ALARME.



Touche SET : pour quitter et enregistrer / confirmer la valeur ; passer au niveau suivant ; ouvrir le menu Réglage. **EN APPUYANT PENDANT 5s ON DÉMARRE LE REFROIDISSEUR.**

4.2 Signification des symboles

Symbole	État du symbole	Fonction	Symbole	État du symbole	Fonction	
	Allumé	Compresseur en marche		Allumé	Valeur de la température	
	Clignotant	Compresseur en veille			Allumé	Valeur de la pression
	Éteint	Compresseur à l'arrêt				Allumé
	Allumé	Alarme en cours		Éteint		Chauffage antigel coupé
	Clignotant	Avertissement ou Alarme réinitialisable				Allumé
	Éteint	Pas d'alarme			Éteint	Chauffage du carter coupé Compresseur 1
		Allumé		Pompe 1 en marche		Allumé
Éteint		Pompe 1 à l'arrêt		Éteint		Chauffage du carter coupé Compresseur 2 (absent)
	Allumé	Pompe 2 en marche (absent)			Allumé	Chauffage du carter en marche Compresseur 2 (absent)
	Éteint	Pompe 2 à l'arrêt (absent)			Éteint	Chauffage du carter coupé Compresseur 2 (absent)

4.3 Démarrage du refroidisseur

1. Brancher l'alimentation de la machine en tournant le sélecteur de l'isolateur principal QS sur ON.
2. Appuyer sur le bouton "set" pour démarrer.
3. Régler la température voulue sur le contrôleur. (parag. 4.5.1)

Moniteur de phase

Si au l'afficheur indique l'alarme «Er 23», l'utilisateur doit vérifier avoir effectué correctement le câblage des bornes en entrée de l'interrupteur sectionneur.

4.3.1 Réglages à la mise en service

1. Réglage de la température, voir le paragraphe 4.5.
2. Réglage de la pompe (uniquement pour version à eau)
Vérifier que la pompe fonctionne correctement à l'aide de la jauge de pression (lire P1 et P0) et en vérifiant les valeurs limite de la pression (Pmax et Pmin) indiquées sur la plaquette des données de la pompe.

P1 = pression à pompe ALLUMÉE

P0 = pression à pompe ÉTEINTE

$P_{min} < (P1 - P0) < P_{max}$

- Exemple n°1.

Conditions :

circuit fermé, pression P0 = 2 bar

valeurs de la plaquette des données de la pompe : Pmin 1 bar/ Pmax 3 bar

régler la sortie de la vanne afin d'obtenir une pression de 3 bar < P1 < 5 bar

- Exemple n°2.

Conditions :

circuit ouvert, pression P0 = 0 bar

valeurs de la plaquette des données de la pompe : Pmin 1 bar/ Pmax 3 bar

régler la sortie de la vanne afin d'obtenir une pression de 1 bar < P1 < 3 bar

3. Vérifier le bon fonctionnement de la pompe en conditions de travail normales.
Vérifier également que l'ampérage de la pompe est compris dans les limites indiquées sur la plaquette des données.
4. Éteindre le refroidisseur et procéder au remplissage d'appoint du circuit hydraulique à la température paramétrée « SET ».
5. Vérifier que la température de l'eau « traitée » ne descend pas sous 5°C et que la température ambiante dans laquelle le circuit hydraulique fonctionne ne descend pas sous 5°C. Si la température est trop basse, ajouter la quantité nécessaire de glycol en suivant les indications fournies au paragraphe 3.3.3

ATTENTION ! : avant de mettre la pompe du chiller en marche, fermez la vanne de sortie d'eau (à installer par le client).

Maintenez toujours la vanne d'admission (à installer par le client) ouverte.

Pour mettre la pompe en marche, ouvrez lentement la vanne de sortie d'eau du chiller et réglez le débit comme décrit au point 4.3.1.

4.4 Arrêt du refroidisseur

Lorsque le refroidisseur n'est plus nécessaire, l'éteindre comme suit : Appuyer sur le bouton "set" (5 sec.).

Ne pas éteindre le sélecteur principal QS, afin de permettre aux dispositifs de protection antigel d'être alimentés.

4.5 Réglages des paramètres

Généralités

Il existe deux niveaux de protection pour les paramètres :

a) Direct User-(U) : à accès immédiat, **Modifiable par l'utilisateur** ;

b) Protégé par mot de passe User- (S) : un mot de passe est requis pour y accéder (**ne pas les modifier**).

4.5.1 Paramètres du refroidisseur (CF9)

PARAMÈTRE	CODE	TYPE	PAR DÉ-FAUT
Unité de mesure.	R1	U	OFF
Gestion du relais d'alarme	CFJ1	U	0
Rétablir les paramètres par défaut	DEF	U	OFF
Mode distant On/Off	R7	U	0
Version du logiciel	UER	U	1.70
Adresse de l'unité	CF30	U	1
Vitesse de transmission (bauds)	CF31	U	3
Protocole Modbus	CF32	U	1
Mode superviseur On/Off	SUP	U	OFF
Activation point de consigne dynamique	ErD	U	OFF

4.5.2 Contrôle de la température (CTP)

PARAMÈTRE	CODE	TYPE	PAR DÉ-FAUT
Point de consigne du contrôle de température (standard)	SET	U	13.0
Point de consigne du contrôle de température (contrôle de précision)	SET	U	20.0
Différentiel de contrôle de la température (NON présent dans la configuration « contrôle de précision »)	dIF1	U	4.0

4.5.3 Paramètres de maintenance (Mnt)

PARAMÈTRE	CODE	TYPE	PAR DÉ-FAUT
Heures de service	UH	U	-
Heures de service (X1000)	UHL	U	-
Heures de service partielles	UPH	U	-
Heures de service partielles (X1000)	UPHL	U	-
Heures de service du compresseur 1	CIH	U	-
Heures de service du compresseur 1 (x1000)	CIHL	U	-

4.5.4 Paramètres de la sonde (bt 1, bt2)

Sonde (bt 1)

PARAMÈTRE	CODE	TYPE	PAR DÉ-FAUT
Alarme haute température (eau)	HR1	U	50

Sonde (bt2)

PARAMÈTRE	CODE	TYPE	PAR DÉ-FAUT
Alarme haute température (eau)	HR2	U	50

4.5.5 Historique des alarmes (ALH i)

PARAMÈTRE	CODE	TYPE	PAR DÉ-FAUT
Numéro d'alarme	HYSP	U	-
Voir le code d'alarme	HYSC	U	-
Afficher le jour et le mois de déclenchement de l'alarme	HYSD	U	-
Voir l'heure et les minutes de déclenchement de l'alarme	HYSE	U	-
Température bt1 au moment du déclenchement de l'alarme	HY51	U	-
Température bt2 au moment du déclenchement de l'alarme	HY52	U	-
Conditions de CONSIGNE au moment du déclenchement de l'alarme	HY53	U	-

4.6 Modification des paramètres (User)

4.6.1 Paramètres du refroidisseur (CF9)

Unité de mesure.

<p>Allumer le refroidisseur « ON » au moyen de l'interrupteur principal QS et attendre que « OFF » apparaisse sur l'écran.</p> <p>Appuyer simultanément sur les touches « esc » « set » pour entrer dans le type de paramètre « U ».</p>	
<p>Le paramètre « PAr » s'affiche.</p> <p>Appuyer sur la touche « set » pour entrer.</p>	
<p>Le paramètre « CF9 » s'affiche.</p> <p>Appuyer sur la touche « set » pour entrer.</p>	
<p>Le paramètre « A1 » s'affiche.</p> <p>Appuyer sur la touche « set » pour entrer.</p>	
<p>La valeur par défaut est « OFF » = °C</p> <p>Utiliser les touches « ∨ » et « ∧ » pour sélectionner l'unité de mesure.</p> <p>OFF : température = C°, Celsius ; pression = Bar; On : température = °F, Fahrenheit; pression = PSI</p>	
<p>Appuyer sur la touche « set » pour confirmer.</p>	
<p>Retour automatique à « A1 »</p> <p>Le paramètre a été enregistré.</p> <p>Appuyer trois fois sur la touche « esc » pour quitter.</p>	

Gestion des alarmes

<p>Allumer le refroidisseur « ON » au moyen de l'interrupteur principal QS et attendre que « OFF » apparaisse sur l'écran.</p> <p>Appuyer simultanément sur les touches « esc » « set » pour entrer dans le type de paramètre « U ».</p>	
<p>Le paramètre « PAr » s'affiche.</p> <p>Appuyer sur la touche « set » pour entrer.</p>	
<p>Le paramètre « CF9 » s'affiche.</p> <p>Appuyer sur la touche « set » pour entrer.</p>	
<p>Le paramètre « A1 » s'affiche.</p> <p>Utiliser les touches « ∨ » et « ∧ » pour sélectionner le paramètre « CFJ1 ».</p>	
<p>Appuyer sur la touche « set » pour entrer.</p>	
<p>La valeur par défaut est « 0 »</p> <p>Utiliser les touches « ∨ » et « ∧ » pour sélectionner la gestion du relais d'alarme (§ 4.5.1- Tab.1)</p>	
<p>Appuyer sur la touche « set » pour confirmer.</p>	
<p>Retour automatique à « CFJ1 »</p> <p>Le paramètre a été enregistré.</p> <p>Appuyer trois fois sur la touche « esc » pour quitter.</p>	

Tab.1 Gestion du relais d'alarme (CFJ1.)

0	Relais normalement désactivé, excité par une alarme.
1	Relais normalement excité (même lorsque la commande est OFF) désactivé par une alarme.
2	Relais normalement excité (uniquement si le contrôle est ON), désactivé par une alarme ou la commande OFF.

Paramètres par défaut

<p>Allumer le refroidisseur « ON » au moyen de l'interrupteur principal QS et attendre que « OFF » apparaisse sur l'écran.</p> <p>Appuyer simultanément sur les touches « esc » « set » pour entrer dans le type de paramètre « U ».</p>	
<p>Le paramètre « <i>PRr</i> » s'affiche.</p> <p>Appuyer sur la touche « set » pour entrer.</p>	
<p>Le paramètre « <i>CF9</i> » s'affiche.</p> <p>Appuyer sur la touche « set » pour entrer.</p>	
<p>Le paramètre « <i>A1</i> » s'affiche.</p> <p>Utiliser les touches « ⏴ » et « ⏵ » pour sélectionner le paramètre « <i>dEF</i> ».</p>	
<p>Appuyer sur la touche « set » pour entrer.</p>	
<p>La valeur par défaut est « <i>OFF</i> »</p> <p>Utiliser les touches « ⏴ » et « ⏵ » pour basculer de « <i>OFF</i> » à « <i>On</i> ».</p>	
<p>Appuyer sur la touche « set » pour confirmer.</p>	
<p>Après quelques secondes, revenir à « <i>OFF</i> ».</p> <p>Les paramètres ont été automatiquement réinitialisés.</p> <p>Appuyer trois fois sur la touche « esc » pour quitter.</p>	







Démarrage à distance ON/OFF

<p>Allumer le refroidisseur « ON » au moyen de l'interrupteur principal QS et attendre que « OFF » apparaisse sur l'écran.</p> <p>Appuyer simultanément sur les touches « esc » « set » pour entrer dans le type de paramètre « U ».</p>	
<p>Le paramètre « <i>PRr</i> » s'affiche.</p> <p>Appuyer sur la touche « set » pour entrer.</p>	
<p>Le paramètre « <i>CF9</i> » s'affiche.</p> <p>Appuyer sur la touche « set » pour entrer.</p>	
<p>Le paramètre « <i>A1</i> » s'affiche.</p> <p>Utiliser les touches « ⏴ » et « ⏵ » pour sélectionner le paramètre « <i>A7</i> ».</p>	
<p>Appuyer sur la touche « set » pour entrer.</p>	
<p>La valeur par défaut est « <i>0</i> »</p> <p>Utiliser les touches « ⏴ » et « ⏵ » pour sélectionner le mode : (§ 4.5.1)</p>	
<p>Appuyer sur la touche « set » pour confirmer.</p>	
<p>Retour automatique à « <i>A7</i> »</p> <p>Le paramètre a été enregistré.</p> <p>Appuyer trois fois sur la touche « esc » pour quitter.</p>	





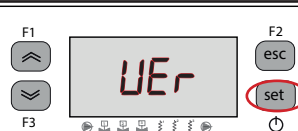

Tab. 2 Mode distant On/Off (A7)

0	On/Off distant désactivé
1	Mode distant On/Off activé et On/Off local activé. En cas de coupure de courant ou si l'interrupteur principal est en position d'arrêt, le refroidisseur doit être redémarré localement une fois l'alimentation électrique rétablie.
2	Uniquement On/Off distant, On/Off local désactivé

Version du logiciel (en lecture seule)

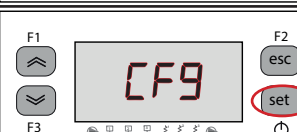
<p>Allumer le refroidisseur « ON » au moyen de l'interrupteur principal QS et attendre que « OFF » apparaisse sur l'écran.</p> <p>Appuyer simultanément sur les touches « esc » et « set » pour entrer dans le type de paramètre « U ».</p>	
<p>Le paramètre « <i>PAR</i> » s'affiche.</p> <p>Appuyer sur la touche « set » pour entrer.</p>	
<p>Le paramètre « <i>CF9</i> » s'affiche.</p> <p>Appuyer sur la touche « set » pour entrer.</p>	
<p>Le paramètre « <i>A1</i> » s'affiche.</p> <p>Utiliser les touches « ⇩ » et « ⇧ » pour sélectionner le paramètre « <i>UER</i> ».</p>	
<p>Appuyer sur la touche « set » pour entrer.</p>	
<p>La version du logiciel est affichée</p>	
<p>Appuyer trois fois sur la touche « esc » pour quitter.</p>	

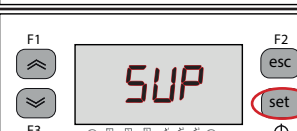
Activation du mode superviseur

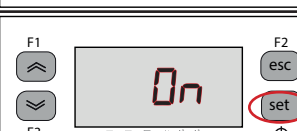
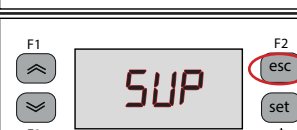
<p>Allumer le refroidisseur « ON » au moyen de l'interrupteur principal QS et attendre que « OFF » apparaisse sur l'écran.</p> <p>Appuyer simultanément sur les touches « esc » et « set » pour entrer dans le type de paramètre « U ».</p>	
<p>Le paramètre « <i>PAR</i> » s'affiche.</p> <p>Appuyer sur la touche « set » pour entrer.</p>	
<p>Le paramètre « <i>CF9</i> » s'affiche.</p> <p>Appuyer sur la touche « set » pour entrer.</p>	
<p>Le paramètre « <i>A1</i> » s'affiche.</p> <p>Utiliser les touches « ⇩ » et « ⇧ » pour sélectionner le paramètre « <i>SUP</i> ».</p>	
<p>Appuyer sur la touche « set » pour entrer.</p>	
<p>La valeur par défaut est « <i>OFF</i> »</p> <p>Utiliser les touches « ⇩ » et « ⇧ » pour la change.</p>	
<p>Appuyer sur la touche « set » pour confirmer.</p>	
<p>Le paramètre a été enregistré.</p> <p>Appuyer trois fois sur la touche « esc » pour quitter.</p>	

Modbus (adresse)

<p>Allumer le refroidisseur « ON » au moyen de l'interrupteur principal QS et attendre que « OFF » apparaisse sur l'écran.</p> <p>Appuyer simultanément sur les touches « esc » et « set » pour entrer dans le type de paramètre « U ».</p>	
<p>Le paramètre « <i>PAR</i> » s'affiche.</p> <p>Appuyer sur la touche « set » pour entrer.</p>	
<p>Le paramètre « <i>CF9</i> » s'affiche.</p> <p>Appuyer sur la touche « set » pour entrer.</p>	
<p>Le paramètre « <i>A 1</i> » s'affiche.</p> <p>Utiliser les touches « ↓ » et « ↑ » pour sélectionner le paramètre « <i>CF30</i> ».</p>	
<p>Appuyer sur la touche « set » pour entrer.</p>	
<p>La valeur par défaut est « <i>1</i> »</p> <p>Utiliser les touches « ↓ » et « ↑ » pour modifier l'adresse.</p>	
<p>Appuyer sur la touche « set » pour confirmer.</p>	
<p>Le paramètre a été enregistré.</p> <p>Appuyer trois fois sur la touche « esc » pour quitter.</p>	

Modbus (protocole)

<p>Allumer le refroidisseur « ON » au moyen de l'interrupteur principal QS et attendre que « OFF » apparaisse sur l'écran.</p> <p>Appuyer simultanément sur les touches « esc » et « set » pour entrer dans le type de paramètre « U ».</p>	
<p>Le paramètre « <i>PAR</i> » s'affiche.</p> <p>Appuyer sur la touche « set » pour entrer.</p>	
<p>Le paramètre « <i>CF9</i> » s'affiche.</p> <p>Appuyer sur la touche « set » pour entrer.</p>	
<p>Le paramètre « <i>A 1</i> » s'affiche.</p> <p>Utiliser les touches « ↓ » et « ↑ » pour sélectionner le paramètre « <i>CF31</i> ».</p>	
<p>Appuyer sur la touche « set » pour entrer.</p>	
<p>La valeur par défaut est « <i>1</i> »</p> <p>Utiliser les touches « ↓ » et « ↑ » pour modifier le protocole. (§ 4.5.1 - Tab. 3)</p>	
<p>Appuyer sur la touche « set » pour confirmer.</p>	
<p>Le paramètre a été enregistré.</p> <p>Appuyer trois fois sur la touche « esc » pour quitter.</p>	

Tab.3 Protocole modbus (en option) (CF31)

1	PAIRE	2	NULLE	3	IMPAIRE
---	-------	---	-------	---	---------

Modbus (vitesse de transmission)

<p>Allumer le refroidisseur « ON » au moyen de l'interrupteur principal QS et attendre que « OFF » apparaisse sur l'écran.</p> <p>Appuyer simultanément sur les touches « esc » et « set » pour entrer dans le type de paramètre « U ».</p>	
<p>Le paramètre « <i>PAR</i> » s'affiche.</p> <p>Appuyer sur la touche « set » pour entrer.</p>	
<p>Le paramètre « <i>CF9</i> » s'affiche.</p> <p>Appuyer sur la touche « set » pour entrer.</p>	
<p>Le paramètre « <i>A1</i> » s'affiche.</p> <p>Utiliser les touches « ↓ » et « ↑ » pour sélectionner le paramètre « <i>CF32</i> ».</p>	
<p>Appuyer sur la touche « set » pour entrer.</p>	
<p>La valeur par défaut est « 3 »</p> <p>Utiliser les touches « ↓ » et « ↑ » pour modifier la vitesse de transmission. (§ 4.5.1 - Tab. 4)</p>	
<p>Appuyer sur la touche « set » pour confirmer.</p>	
<p>Le paramètre a été enregistré.</p> <p>Appuyer trois fois sur la touche « esc » pour quitter.</p>	

Tab.4 Vitesse de transmission (en option) (CF32)

1	2400	3	9600	5	38400	7	115200
2	4800	4	19200	6	57600		

Remarque : si vous modifiez les paramètres du MODBUS, vous devez éteindre le refroidisseur puis le rallumer pour valider les nouveaux paramètres.

Activation de ERD

<p>Allumer le refroidisseur « ON » au moyen de l'interrupteur principal QS et attendre que « OFF » apparaisse sur l'écran.</p> <p>Appuyer simultanément sur les touches « esc » et « set » pour entrer dans le type de paramètre « U ».</p>	
<p>Le paramètre « <i>PAR</i> » s'affiche.</p> <p>Appuyer sur la touche « set » pour entrer.</p>	
<p>Le paramètre « <i>CF9</i> » s'affiche.</p> <p>Appuyer sur la touche « set » pour entrer.</p>	
<p>Le paramètre « <i>A1</i> » s'affiche.</p> <p>Utiliser les touches « ↓ » et « ↑ » pour sélectionner le paramètre « <i>ErD</i> ».</p>	
<p>Appuyer sur la touche « set » pour entrer.</p>	
<p>La valeur par défaut est « OFF »</p> <p>Utiliser les touches « ↓ » et « ↑ » pour la change.</p>	
<p>Appuyer sur la touche « set » pour confirmer.</p>	
<p>Le paramètre a été enregistré.</p> <p>Appuyer trois fois sur la touche « esc » pour quitter.</p>	

Lorsque le paramètre ERD est activé : La température de consigne de l'eau change en fonction de la température ambiante. La fonction n'est active que si le contrôle de la précision de la température est désactivé (CPT=OFF).

4.6.2 Contrôle de la température « CNP »

Réglage du contrôle de la température

<p>Allumer le refroidisseur « ON » au moyen de l'interrupteur principal QS et attendre que « OFF » apparaisse sur l'écran.</p> <p>Appuyer simultanément sur les touches « esc » « set » pour entrer dans le type de paramètre « U ».</p>	
<p>Le paramètre « PAr » s'affiche.</p> <p>Appuyer sur la touche « set » pour entrer.</p>	
<p>Le paramètre « CF9 » s'affiche.</p> <p>Utiliser les touches « >> » et « << » pour sélectionner le paramètre « CNP ».</p>	
<p>Appuyer sur la touche « set » pour entrer.</p>	
<p>Le paramètre « SEt » s'affiche.</p> <p>Appuyer sur la touche « set » pour entrer.</p>	
<p>La valeur par défaut est « 13.0 »</p> <p>Utiliser les touches « >> » et « << » pour modifier la valeur.</p>	
<p>Appuyer sur la touche « set » pour confirmer.</p>	
<p>Le paramètre a été enregistré.</p> <p>Appuyer trois fois sur la touche « esc » pour quitter.</p>	

Important : La température doit être réglée entre 1°C et 5°C par des techniciens spécialisés sur la base des instructions figurant dans le manuel d'entretien de ce produit.

Réglage du différentiel de température

<p>Allumer le refroidisseur « ON » au moyen de l'interrupteur principal QS et attendre que « OFF » apparaisse sur l'écran.</p> <p>Appuyer simultanément sur les touches « esc » « set » pour entrer dans le type de paramètre « U ».</p>	
<p>Le paramètre « PAr » s'affiche.</p> <p>Appuyer sur la touche « set » pour entrer.</p>	
<p>Le paramètre « CF9 » s'affiche.</p> <p>Utiliser les touches « >> » et « << » pour sélectionner le paramètre « CNP ».</p>	
<p>Appuyer sur la touche « set » pour entrer.</p>	
<p>Le paramètre « SEt » s'affiche.</p> <p>Utiliser les touches « >> » et « << » pour sélectionner le paramètre « d i F l ».</p>	
<p>Appuyer sur la touche « set » pour entrer.</p>	
<p>La valeur par défaut est « 4.0 »</p> <p>Utiliser les touches « >> » et « << » pour modifier la valeur.</p>	
<p>Appuyer sur la touche « set » pour confirmer.</p>	
<p>Le paramètre a été enregistré.</p> <p>Appuyer trois fois sur la touche « esc » pour quitter.</p>	

4.6.3 Paramètre sonde « bt 1 »

Sonde « bt 1 ».

<p>Allumer le refroidisseur « ON » au moyen de l'interrupteur principal QS et attendre que « OFF » apparaisse sur l'écran.</p> <p>Appuyer simultanément sur les touches « esc » « set » pour entrer dans le type de paramètre « U ».</p>	
<p>Le paramètre « PA_r » s'affiche.</p> <p>Appuyer sur la touche « set » pour entrer.</p>	
<p>Le paramètre « CF9 » s'affiche.</p> <p>Utiliser les touches « >> » et « << » pour sélectionner le paramètre « bt 1 ».</p>	
<p>Appuyer sur la touche « set » pour entrer.</p>	
<p>Le paramètre « HA 1 » s'affiche.</p> <p>Appuyer sur la touche « set » pour entrer.</p>	
<p>La valeur par défaut est « 60.0 »</p> <p>Utiliser les touches « >> » et « << » pour modifier la valeur.</p>	
<p>Appuyer sur la touche « set » pour confirmer.</p>	
<p>Le paramètre a été enregistré.</p> <p>Appuyer trois fois sur la touche « esc » pour quitter.</p>	























Même séquence pour la sonde « bt2 ».

4.7 Visualisation des sondes de température (en lecture seule)

<p>Refroidisseur en marche.</p> <p>Appuyer sur la touche « >> » pour afficher la page des avertissements. <i>bt 1, bt 2, bt 3, bP 1</i></p>	
<p>Sélectionner la sonde et attendre quelques secondes. (Ex. BT2)</p>	
<p>La valeur de la sonde bt 2 s'affiche.</p>	
<p>Il est conseillé de toujours revenir à la sonde bt 1</p>	

Capteur	Description
bt 1	Température de l'eau
bt 2	Température d'évaporation
bt 3	Température ambiante
bt 10	Température du tableau électrique
bP 1	Pression du ventilateur 1

4.8 Réglage de l'heure/la date



<p>Allumer le refroidisseur « ON » au moyen de l'interrupteur principal QS et attendre que « OFF » apparaisse sur l'écran.</p> <p>Appuyer simultanément sur les touches «  » et «  » pour afficher le menu « Date/heure ».</p>	
<p>Le paramètre « FrEE » s'affiche.</p> <p>Appuyer sur la touche «  » pour entrer.</p>	
<p>Le paramètre « A1 » s'affiche.</p> <p>Utiliser les touches «  » et «  » pour sélectionner le paramètre « CL ».</p>	
<p>Appuyer sur la touche «  » pour entrer.</p>	
<p>Le paramètre « HOUR » s'affiche.</p> <p>Appuyer sur la touche pendant 5 secondes «  ».</p> <p>Le paramètre se met à clignoter.</p>	
<p>Utiliser les touches «  » et «  » pour sélectionner la date, l'heure ou l'année et les modifier.</p>	
<p>Appuyer sur la touche «  » pour entrer.</p>	
<p>Utiliser les touches «  » et «  » pour modifier la valeur (ex : année)</p>	
<p>Appuyer sur la touche «  » pour confirmer.</p>	

Utiliser les touches «  » et «  » pour modifier une autre valeur (ex : date)



Appuyer sur la touche «  » pour quitter
Le paramètre cesse de clignoter.













Appuyer simultanément sur les touches «  » et «  » pour quitter.



⚠ La mémoire de l'« horloge/date » dure trois jours au maximum. Si le contrôleur reste sans alimentation pendant plus de trois jours, l'heure/le mois/l'année paramétrés seront donc perdus. Régler l'horloge lors de la mise en marche de la machine et chaque fois que cela est nécessaire.

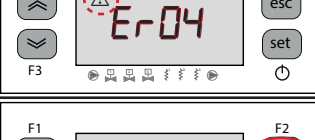



4.9 Gestion des alarmes

<p>En présence d'une alarme, le code d'alarme et un symbole s'affichent dans le coin supérieur gauche de l'écran.</p> <p> Fixe = alarme présente Clignotant = avertissement présent/ Alarme réinitialisable</p>	
<p>Appuyer sur la touche « set » pour entrer.</p>	
<p>Le paramètre « ALH , » s'affiche.</p> <p>Appuyer sur la touche «  » pour sélectionner le paramètre « AL ».</p>	
<p>Appuyer sur la touche « set » pour entrer.</p>	
<p>Le code de l'alarme s'affiche ex. :« Er04 ».</p> <p>Appuyer sur la touche «  » pour contrôler la présence éventuelle d'autres alarmes.</p>	
<p>Remédier à l'anomalie avant de procéder à la réinitialisation. Une fois l'anomalie éliminée, le symbole d'alarme commence à clignoter. Il est maintenant possible de procéder à la réinitialisation.</p>	
<p>Appuyer sur la touche « esc » jusqu'à la suppression de l'alarme.</p>	

Liste des alarmes et avertissements

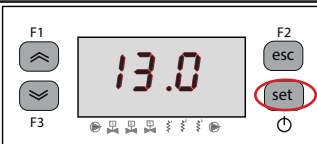
Code	Description	Action	Réinitialisation
Er01	Coupure ou rupture du capteur bt1	Alarme	A
Er02	Coupure ou rupture du capteur bt2	Alarme	A
Er03	Coupure ou rupture du capteur bt3	Alarme	A
Er05	Coupure ou rupture du capteur bt10	Alarme	A
Er06	Coupure ou rupture du capteur bP1	Alarme	A
Er08	Circuit du pressostat de haute pression 1	Alarme	A
Er09	Circuit du pressostat de basse pression 1	Alarme	A
Er12	Haute température bt1	Alarme	A
Er13	Basse température bt1	Alarme	A
Er14	Haute température bt2	Alarme	A
Er15	Basse température bt2	Alarme	A
Er16	Haute température bt3	Alarme	A
Er17	Basse température bt3	Alarme	A
Er18	Protection thermique du compresseur 1	Alarme	A
Er20	Protection thermique de la pompe 1	Alarme	A
Er22	Bas niveau d'eau / Pressostat différentiel	Alarme	A
Er23	Moniteur phase	Alarme	A
Er24	Rupture ou déconnexion de l'extension	Alarme	A
Er25	Nombre d'heures de fonctionnement du compresseur 1 dépassé	Avertissement	A
Er27	Nombre d'heures de fonctionnement de l'unité dépassé	Avertissement	A
Er28	Mémoire d'horloge	Avertissement	A
Er29	Configuration du refroidisseur	Avertissement	A

4.10 Historique des alarmes





Refroidisseur en marche. Appuyer sur la touche « set » pour afficher la page des alarmes.	
Appuyer sur la touche « set » pour quitter	
Utiliser les touches « >>> » et « <<< » pour afficher les paramètres. (§ 4.5.5)	
Appuyer sur la touche « set » pour afficher la valeur.	

5 Entretien

• La machine est conçue et construite pour garantir un fonctionnement continu ; la durée de ses composants dépend cependant directement de l'entretien effectué.

-  En cas de demande d'assistance ou de pièces détachées, identifier la machine (modèle ou numéro de série) en lisant la plaque d'identification placée sur la carrosserie de l'unité. (**www.polewr.com.**)

5.1 Recommandations générales

-  Avant tout entretien vérifier que le réfrigérateur ne soit plus alimenté.
-  Utiliser toujours des pièces de rechange d'origine ; dans le cas contraire, le constructeur est dégagé de toute responsabilité pour le mauvais fonctionnement de la machine.
-  En cas de fuite du réfrigérant, appeler un professionnel qualifié et agréé par le constructeur.
-  La vanne ou valve Schrader ne doit être utilisée qu'en cas d'anomalie de fonctionnement de la machine : dans le cas contraire, les dommages causés par une charge de réfrigérant incorrecte ne seront pas reconnus au titre de la garantie.

5.2 Réfrigérant











Opération de charge : les dommages éventuels causés par une charge incorrecte effectuée par un personnel non habilité ne seront pas reconnus au titre de la garantie. 

-  L'appareil contient des gaz à effet de serre fluorés.
Le fluide frigorigène R513A à température et pression normales est un gaz incolore appartenant au SAFETY GROUP A1 - EN378 (fluide groupe 2 selon la directive PED 2014/68/UE); GWP (Global Warming Potential) = 573.

-  En cas de fuite de réfrigérant, aérer le local.

5.3 Entretien préventif ou prédictif

Pour garantir dans le temps l'efficacité maximum et la fiabilité de l'appareil procéder comme suit :

Description opération d'entretien	Périodicité d'entretien recommandée (conditions de fonctionnement standard)			
	Tous les jours	Tous les 6 mois	Tous les 12 mois	Tous les 36 mois
<p align="center">Opération</p> <p align="center">contrôler  Service </p>				
Contrôler que le témoin POWER ON est allumé				
Contrôler les indicateurs du tableau des commandes.				
Nettoyer les ailettes du condenseur				
Contrôler la consommation électrique.				
Contrôler les fuites de réfrigérant.				
Nettoyer la Soupape de sûreté (si présent)				
Contrôler les sondes de température. Remplacer si nécessaire.				 
Kit d'entretien				



 The following are available (see par 7.):

- a) Kit d'entretien:
- kit électrique;
 - kit compresseur;
 - kit ventilateur;
 - kit vanne d'expansion;
 - kit évaporateur;
 - kit pompe;
 - kit réservoir eau;
- b) pièces détachées.

5.4 Mise au rebut

Le fluide frigorigène et le lubrifiant (huile) contenus dans le circuit devront être récupérés selon la législation antipollution.

La récupération du fluide réfrigérant est effectuée avant la destruction définitive de l'équipement ((UE) N° 517/2014 art.8).

	RECYCLAGE DÉMANTÈLEMENT 
charpenterie	acier/résines époxy, polyester
réservoir	aluminium/cuivre/acier
tuyauterie/collecteurs	cuivre/aluminium/acier au carbone
isolation tuyauterie	caoutchouc nitrile (NBR)
compresseur	acier/cuivre/aluminium/huile
condenseur	acier/cuivre/aluminium
pompe	acier/fonte/laiton
ventilateur	aluminium
réfrigérant	R513A
vannes	laiton/cuivre
câbles électriques	cuivre/PVC

Les équipements contenant des composants électriques doivent être éliminés séparément avec les déchets électriques et électroniques conformément à la législation locale et en vigueur.



6 Dépannage

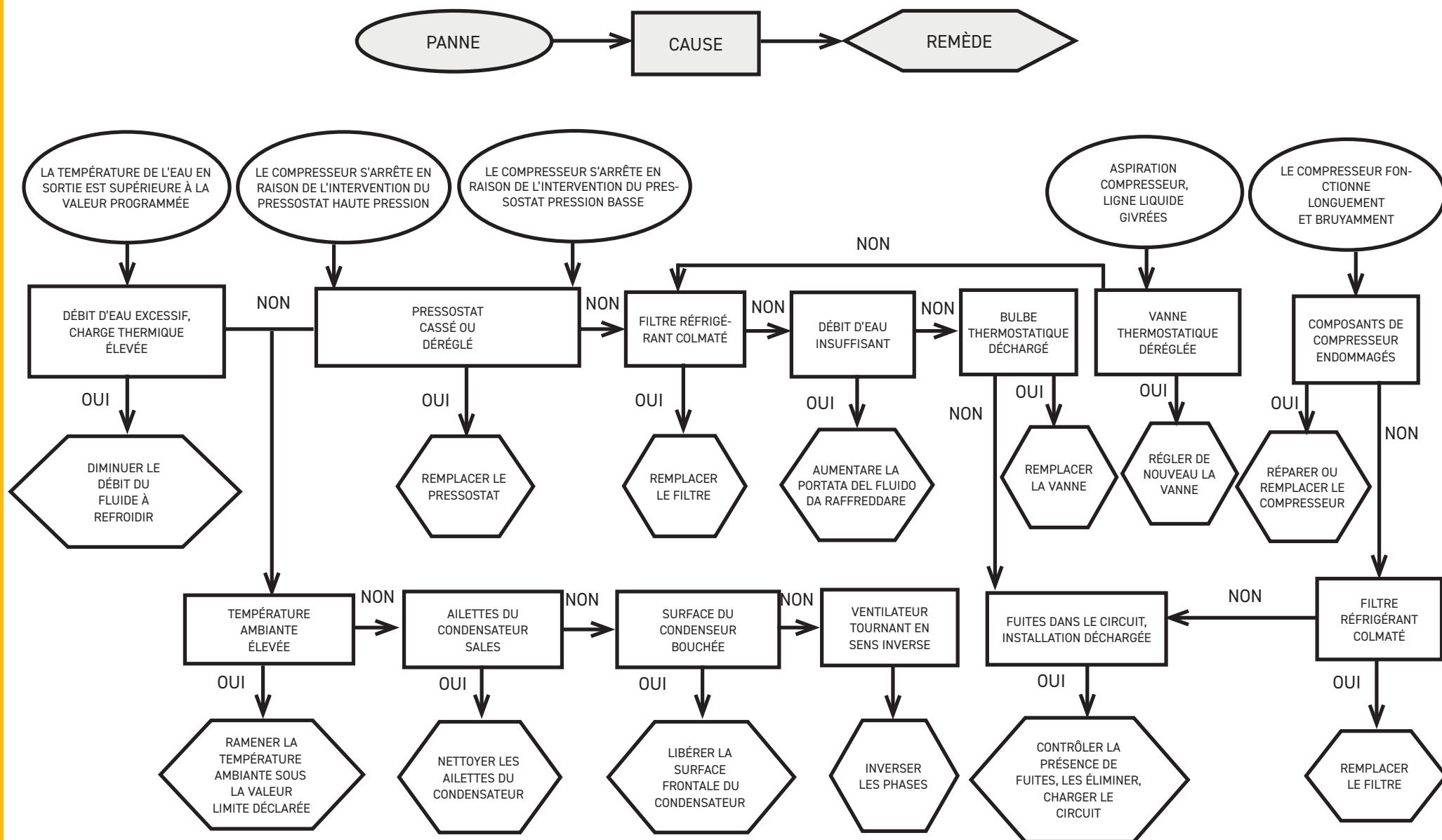

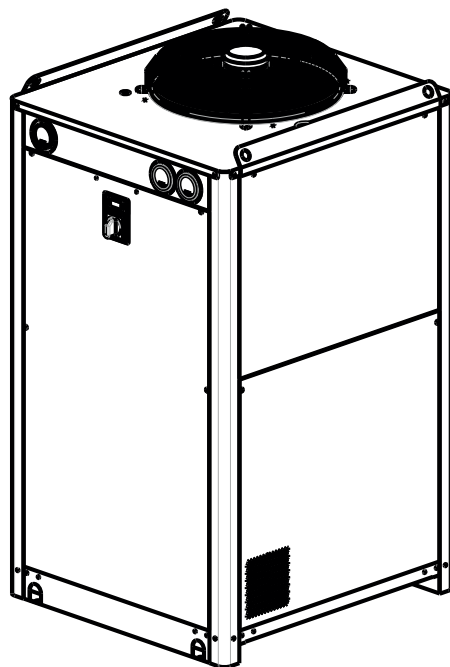
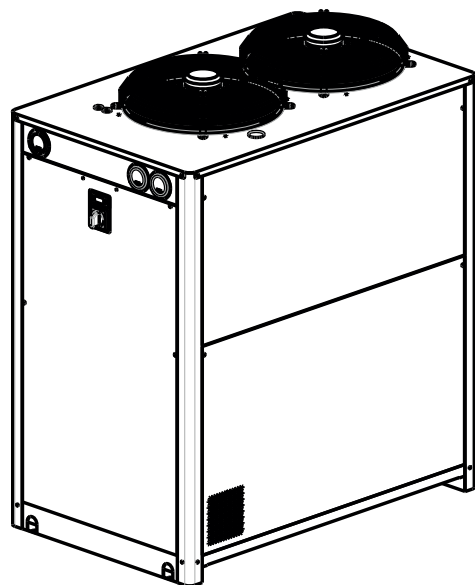











CONTENTS

7.1 Legend	2
7.2 Installation diagram.....	9
7.3 Handling, operating space	10
7.4 Technical data	11
Ecodesign requirements.....	12
Modbus.....	13
7.5 Dimensional drawings ICEP008-015E	18
Dimensional drawings ICEP022E	19
Dimensional drawings ICEP027E.....	20
Dimensional drawings - External tank	21
7.6 Spare parts	22
7.7 Exploded drawing ICEP008-011-015E	24
Exploded drawing ICEP022E	25
Exploded drawing ICEP027E	26
7.8 Circuit Diagram ICEP008-015E	27
Circuit Diagram ICEP022E	28
Circuit Diagram ICEP027E	29
7.9 Wiring diagram ICEP008-015E (standard)	30
Wiring diagram ICEP022-027E (standard)	45

7.1 Legend

Simbol	ES/EN	FR		
A	Versión condensado por aire (ventiladores axiales) Air-cooled version (axial fans)	Version condensation à air (ventilateurs axiaux)		
LAT	Opción baja temperatura ambiente Low ambient temperature option	Option basse température ambiante		
NP	Opción sin bomba No pump option	Option sans pompe		
AH	Opción resistencia antihielo Antifreeze heating element option	Option résistance antigel		
	Peso Weight	Poids		
 Amb	Temperatura ambiente Ambient temperature	Température ambiante		
	Durante el transporte y el almacenamiento During transport and stockage	Pendant le transport et l'entreposage		
	Tras la colocación After installation	Après l'installation		
	Entrada de agua Water inlet	Entrée d'eau		
	Salida de agua Water outlet	Sortie d'eau		

7.1 Legend

Simbol	ES/EN	FR		
	Carga/Descarga del agua Water charge / drain	Recharger / Evacuation eau		
	Nivel de presión sonora (distancia de 10m al aire libre - según la ISO 3746) Sound pressure level (10m distance in free field - according to ISO 3746).	Niveau de pression sonore à 10 mètre de distance en champ libre (selon norme ISO 3746).		
% gly	Porcentaje de glicol % glycols	% glycole		
Max 	Presión de trabajo máx. del lado del aire Air-side max. working pressure	Pression maximum d'utilisation côté air		
	Valores de calibración Calibration values	Valeurs de réglage		
	centro de gravedad centre of gravity	centre de gravité		
0	Cable de sección mínima validado para la conexión eléctrica. Minimum section validated cable for electrical connection.	Section minimale câble homologué pour le raccordement électrique.		
IP	Grado de protección Protection degree	Degré de protection		
▲▲▲	Salida aire de condensación Condensation air outlet	Sortie air de condensation		

7.1 Legend

Simbol	ES/EN	FR		
△ △ △	Entrada aire de condensación Condensation air inlet	Entrée air de condensation		
	Entrada del suministro eléctrico Electrical supply inlet	Entrée alimentation électrique		
----- --	Opcional Optional	Option		
-----	Límite del equipo Limit of equipmen	Limite de l'appareil		
①	Compresor Compressor	Compresseur		
②	Condensador refrigerante Refrigerant condenser	Condenseur réfrigérant		
③	Motor del ventilador Fan motor	Électroventilateur		
④	Filtro refrigerante Refrigerant filter	Filtre réfrigérant		
⑤	Válvula de expansión Expansion valve	Vanne d'expansion		
⑥	Scambiatore a piastra - evaporatore Intercambiador de placas - Evaporador Plate type heat exchanger - evaporator	Échangeur à plaques - Évaporateur		

7.1 Legend

Simbol	ES/EN	FR		
⑦	Bomba Pump	Pompe		
⑧	Depósito de agua Water tank	Réservoir eau		
⑨	Válvula de drenaje de agua Water drain valve	Soupape de décharge de l'eau		
⑩	Salida de aire Air-hole	Évacuation de l'air		
⑪	Manómetro del agua Water manometer	Manomètre eau		
⑫	Conexión de presión Pressure connection	Câble alimentation électrique		
⑬	Sonda de temperatura del agua de salida Water outlet temperature sensor	Sonde température eau en sortie		
⑭	Sonda de temperatura del evaporador Evaporator temperature sensor	Sonde température évaporateur		
⑮	Sensor de nivel de agua Water level sensor	Capteur niveau eau		
⑯	Control electrónico Electronic control	Contrôle électronique		
A1				

7.1 Legend

Simbol	ES/EN	FR		
17	Presostato diferencial de agua Differential water pressure switch	Pressostat différentiel eau		
18	Presostato de alta presión High pressure switch	Pressostat haute pression		
19	Niederdruckwächter Presostato baja presión Low pressure switch	Pressostat basse pression		
20	Manómetro entrada refrigerante Refrigerant suction manometer	Manomètre aspiration réfrigérant		
21	Manómetro salida refrigerante Refrigerant discharge manometer	Manomètre refoulement réfrigérant		
22	Electroválvula del gas caliente 1 Hot gas solenoide valve 1	Électrovanne gaz chaud 1		
23	Electroválvula del gas caliente 2 Hot gas solenoide valve 2	Électrovanne gaz chaud 2		
24	Mirilla de flujo Sight glass	Témoin de débit		
25	Transmisor de alta presión High pressure transmitter	Transmetteur haute pression		
26	Sonda temperatura ambiente Ambient temperature sensor	Sonde température ambiante		

7.1 Legend

Simbol	ES/EN	FR		
28	válvula sin retorno No return valve	Vanne de non-retour		
WPV 29	Válvula presostática agua Water pressostatic valve	Vanne pressostatique à eau		
30	Válvula de seguridad Safety valve	Soupape de sûreté		
QS	Interruptor seccionador gèneral Main disconnect switch	Interrupteur sectionneur général		
QF1	Interruptor automático compresor/ventilador/bomba Automatic compressor/fan/pump switch	Interrupteur automatique compresseur/ventilateur/pompe		
TC1	Transformador auxiliares Auxiliary transformer	Transformateur auxiliaires		
KM1	Contactador compresor Compressor contactor	Contacteur compresseur		
KM5	Contactador ventilador Fan contactor	Contacteur ventilateur		
KM7	Contactador bomba Pump contactor	Contacteur pompe		
FV1	Monitor de fase Phase monitor	Moniteur de phase		
Ecod.	Reglamento (EU) N.2016/2281 de las enfriadoras de procesos de alta temperatura Regulation (EU) N.2016/2281 for high temperature process chiller.	Règlement (UE) 2016/2281 , aux refroidisseurs industriels haute température		

7.1 Legend

Simbol	ES/EN	FR		
t	Temperatura de funcionamiento Operating temperature	Température de service		
Q	Consumo anual de electricidad Annual electricity consumption	Consommation annuelle d'électricité		
SERP	Factor de rendimiento energético estacional Seasonal energy performance ratio	Ratio de performance énergétique saisonnier		
	Parámetros a plena carga y a temperatura ambiente de referencia en el punto de clasificación Parameters at full load and ambient temperature	Paramètres à pleine charge et à la température ambiante de référence au point d'évaluation		
P_A	Potencia nominal de refrigeración Rated refrigeration capacity	Puissance de réfrigération nominale		
D_A	Potencia utilizada nominal Rated power input	Puissance absorbée nominale		
EER_{DC,A}	Factor de eficiencia energética nominal Rated energy efficiency ratio	Coefficient d'efficacité énergétique nominal		
P_{B/C/D}	Potencia de refrigeración declarada Declared refrigeration capacity	Puissance de réfrigération déclarée		
D_{B/C/D}	Potencia utilizada declarada Declared power input	Puissance absorbée déclarée		
EER_{DC,..}	Factor de eficiencia energética declarado Declared energy efficiency ratio	Coefficient d'efficacité énergétique déclaré		
	Control de la potencia Capacity control	Régulation de la puissance		
C_{dc}	Coefficiente de degradación de los enfriadores Degradation co-efficient chillers	Coefficient de dégradation Jäähdytyslaitteiden alenemiskerroin		

7.2 Installation diagram

Pos.	DESCRIPTION	DENOMINAZIONE
1	Ball valves	Valvole di intercettazione
2	External pump *	Pompa esterna
2.1	Pump (chiller)	Pompa (chiller)
3	Gauges	Manometri
4	Water filter	Filtro a rete
5	Air bleed valve **	Sfiato
5.1	Air bleed valve (chiller)	Sfiato (chiller)
6	Water drain valve	Valvola di scarico acqua
7	Charge group	Gruppo di carica
7.1	Gauge	manometro
7.2	Non return valve	valvola di non ritorno
7.3	Water fill hose	tubo di alimentazione scollegabile
7.4	Pressure reducer	riduttore di pressione
8	Tank	Serbatoio
9	Expansion Tank	Vaso espansione
10	Safety valve	Valvola disicurezza
11	Flexible union	Giunto flessibile
12	Pressure switch	Pressostato

* The pump must be installed near the tank

** It must be installed at the highest point of the circuit

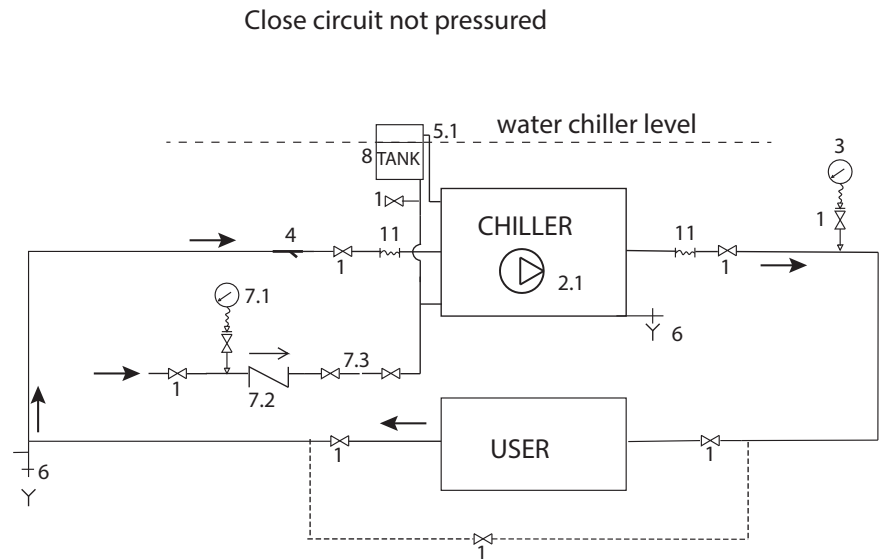
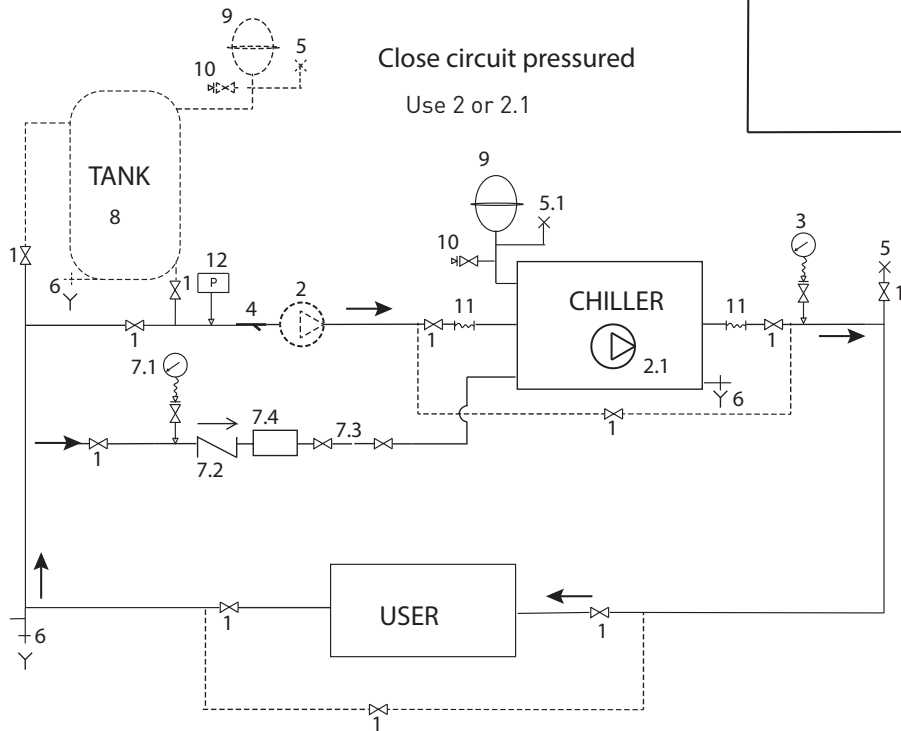
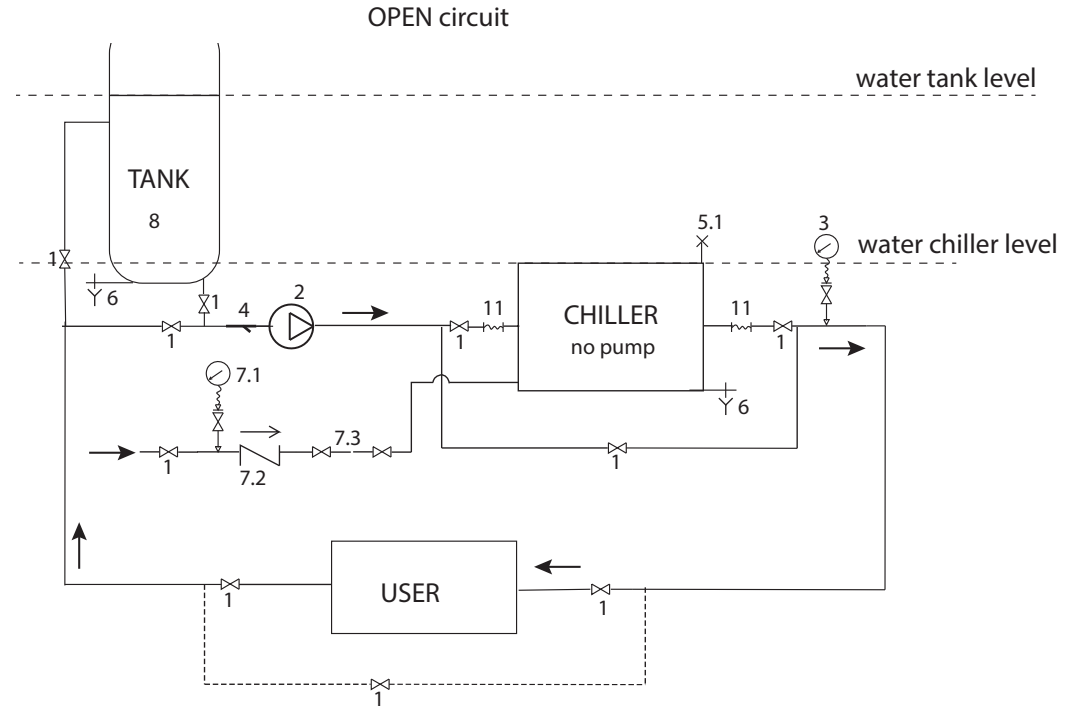

7.3 Handling, operating space



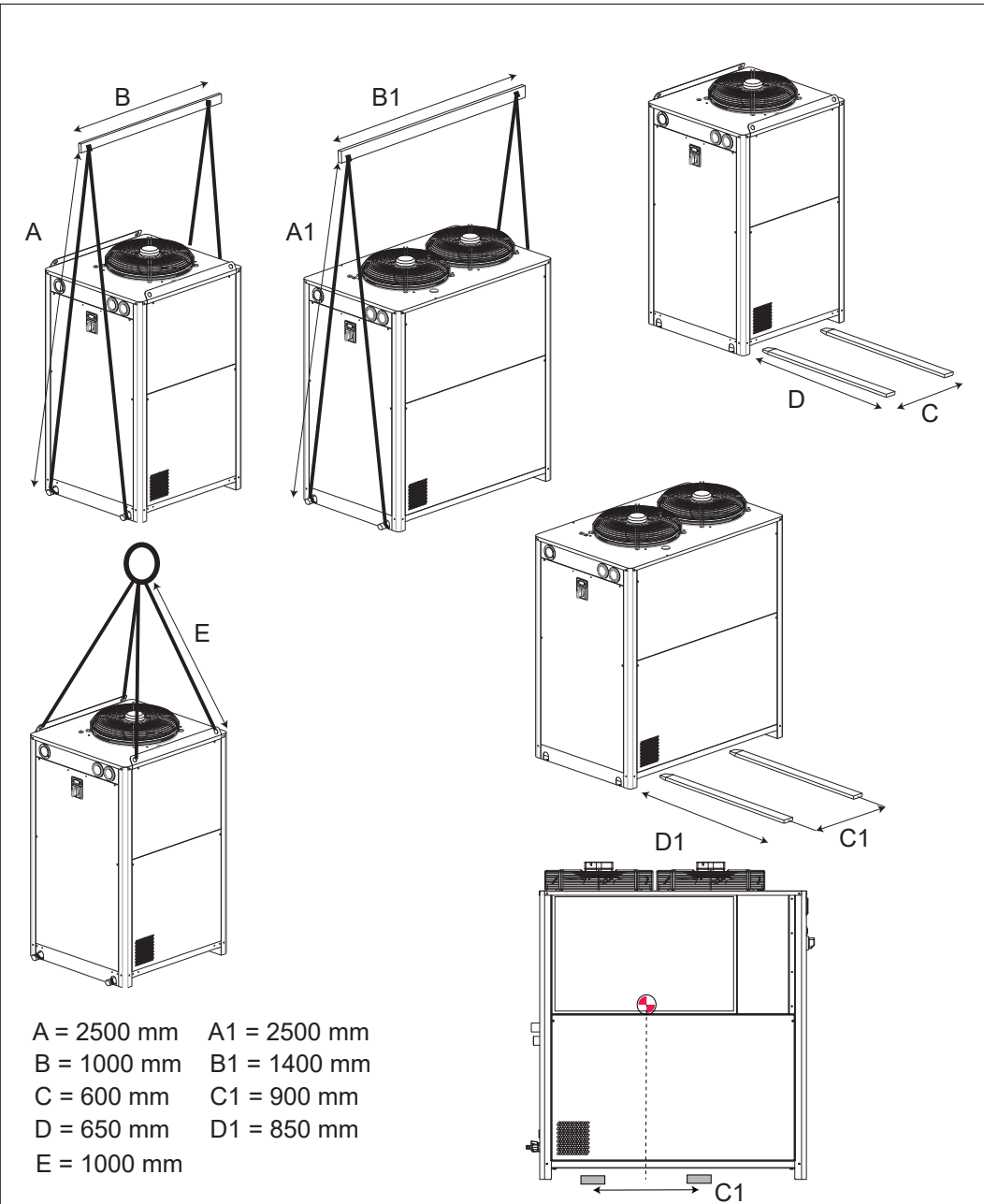



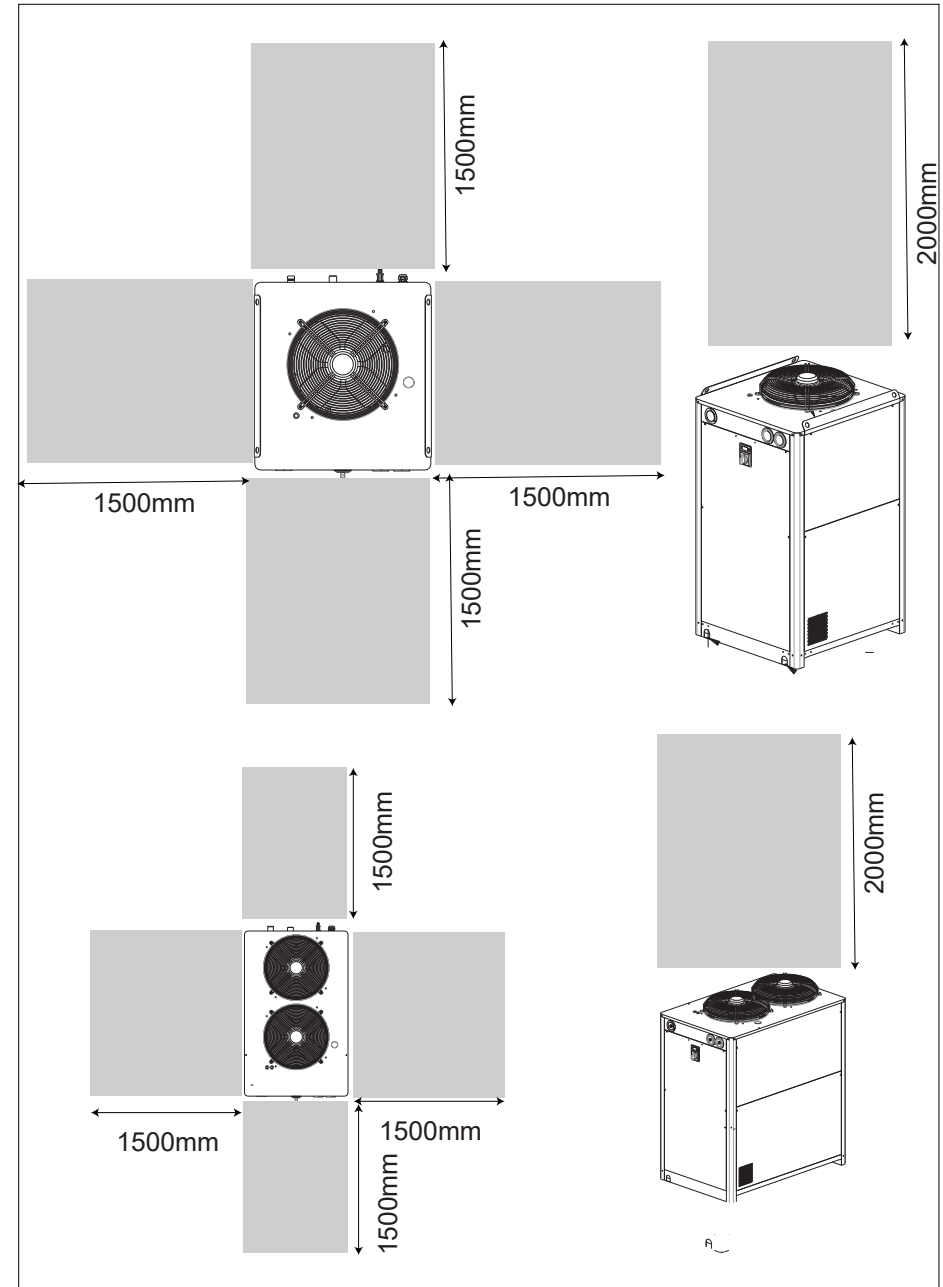

Handling



Operating space



7.4 Technical data

MODEL	 Weight	Dimensions (mm)			Amb 		Connections		 dB[A]	% gly	Max 	Tank capacity (water) (l)
	Air cooled	Width	Depth	Height							water	
ICEP008E	165	756	806	1430	0 °C / 50°C	5 °C / 48°C	3/4" NPT-F	1/2" BSP F	50	40	6 bar	65
ICEP011E	175	756	806	1430			3/4" NPT-F					65
ICEP015E	180	756	806	1430			3/4" NPT-F					65
ICEP022E	235	756	1206	1430			1" NPT-F					100
ICEP027E	250	756	1206	1430			1" NPT-F					100

MODEL	R513A		Power supply				F.L.A. (Full Load Ampere)[A]						IP
	Air cooled			LP1 bar	HP1 bar	Fan bar	MC1	EV		P			
	Kg	CO ₂ (t) Equivalent					A	A	Air flow m ³ /h	P15 (1,5 Barg) A	P30 (3 Barg) A	P50 (5 Barg) A	
ICEP008E	1.5	0.86	460V±10% 3ph 60Hz	1.0	20.0	ON 8.0 OFF 11.0	6.1	0.35	3325	/	1.2	1.81	54
ICEP011E	1.6	0.92					8.3	0.35	3325	/	1.2	1.81	
ICEP015E	1.65	0.95					9.6	1.02	5028	/	1.13	2.42	
ICEP022E	2.5	1.43					12.8	2 x 1.02	7823	/	1.71	2.42	
ICEP027E	4.7	2.69					19.2	2 x 1.02	10865	/	1.71	3.14	

Ecodesign requirements

REGULATION (EU) N. 2016/2281 FOR HIGH TEMPERATURE PROCESS CHILLERS

Model	ICEP008E (air condenser)			ICEP011E (air condenser)			ICEP015E (air condenser)			ICEP022E (air condenser)			ICEP027E (air condenser)		
	Symbol	Value	Unit	Symbol	Value	Unit	Symbol	Value	Unit	Symbol	Value	Unit	Symbol	Value	Unit
Refrigerant : R513A															
Operating temperature	t	7°C	°C	t	7°C	°C	t	7°C	°C	t	7°C	°C	t	7°C	°C
Annual electricity consumption	Q	7600	kWh/a	Q	10862	kWh/a	Q	15642	kWh/a	Q	20244	kWh/a	Q	26480	kWh/a
Seasonal energy performance ratio	SEPR	5,34	[-]	SEPR	5,4	[-]	SEPR	5,01	[-]	SEPR	5,5	[-]	SEPR	5,2	[-]
Parameters at full load and ambient temperature 35°C (Point A)															
Rated refrigeration capacity	P _A	5,49	kW	P _A	7,88	kW	P _A	10,7	kW	P _A	15,49	kW	P _A	18,53	kW
Rated power input	D _A	1,893	kW	D _A	2,67	kW	D _A	4,05	kW	D _A	5,46	kW	D _A	6,46	kW
Rated energy efficiency ratio	EER _{DC,A}	2,9	[-]	EER _{DC,A}	2,95	[-]	EER _{DC,A}	2,64	[-]	EER _{DC,A}	2,836	[-]	EER _{DC,A}	2,868	[-]
Parameters at full load and ambient temperature 25°C (Point B)															
Declared refrigeration capacity	P _B	6,11	kW	P _B	8,83	kW	P _B	12	kW	P _B	17,37	kW	P _B	20,71	kW
Declared power input	D _B	1,55	kW	D _B	2,20	kW	D _B	3,30	kW	D _B	4,43	kW	D _B	5,31	kW
Declared energy efficiency ratio	EER _{DC,B}	3,95	[-]	EER _{DC,B}	4,01	[-]	EER _{DC,B}	3,6355	[-]	EER _{DC,B}	3,924	[-]	EER _{DC,B}	3,9	[-]
Parameters at full load and ambient temperature 15°C (Point C)															
Declared refrigeration capacity	P _C	6,67	kW	P _C	9,69	kW	P _C	13,19	kW	P _C	19,08	kW	P _C	22,66	kW
Declared power input	D _C	1,27	kW	D _C	1,82	kW	D _C	2,69	kW	D _C	3,57	kW	D _C	4,41	kW
Declared energy efficiency ratio	EER _{DC,C}	5,26	[-]	EER _{DC,C}	5,31	[-]	EER _{DC,C}	4,9	[-]	EER _{DC,C}	5,35	[-]	EER _{DC,C}	5,136	[-]
Parameters at full load and ambient temperature 5°C (Point D)															
Declared refrigeration capacity	P _D	7,18	kW	P _D	10,46	kW	P _D	14,28	kW	P _D	20,62	kW	P _D	24,39	kW
Declared power input	D _D	1,06	kW	D _D	1,55	kW	D _D	2,21	kW	D _D	2,86	kW	D _D	3,75	kW
Declared energy efficiency ratio	EER _{DC,D}	6,75	[-]	EER _{DC,D}	6,75	[-]	EER _{DC,D}	6,47	[-]	EER _{DC,D}	7,2	[-]	EER _{DC,D}	6,5	[-]
Others items															
Capacity control	Fixed			Fixed			Fixed			Fixed			Fixed		
Degradation co-efficient chillers	C _{dc}	0,9	[-]	C _{dc}	0,9	[-]	C _{dc}	0,9	[-]	C _{dc}	0,9	[-]	C _{dc}	0,9	[-]
GWP of refrigerant	GWP	573	kg CO _{2eq} / (100 y)	GWP	573	kg CO _{2eq} / (100 y)	GWP	573	kg CO _{2eq} / (100 y)	GWP	573	kg CO _{2eq} / (100 y)	GWP	573	kg CO _{2eq} / (100 y)

Modbus

MODBUS (Modicon standard "so 1-based addressed")

All the variables are access as Holding register (Modbus function FC03, 40000).

Address with offset 40000 (es: 8964+40000=48964)

As standard configuration, RS-485 baudrate 38400, 8bit, Even, stop 1 address 1, you can change it by the display from size ICEP-E005 to ICEP-E120.

Address with offset 40000 (es: 8964+40000=48964)

Modbus TCP/IP is an optional kit.

Tag	Adress		Type	Acces	Description	u.m.	ICEP-E 005	ICEP-E 008 / 065	ICEP-E 080/ 120
iVER	8960	-	UINT	RO	PLC software version	X	Yes	Yes	Yes
B1	8961	-	INT	RO	Water temperature	1/10°C; 1/10°F	Yes	Yes	Yes
B2	8962	-	INT	RO	Evaporation temperature	1/10°C; 1/10°F	Yes	Yes	Yes
B3	8963	-	INT	RO	Ambient temperature	1/10°C; 1/10°F	Yes	Yes	Yes
-	8964	-	-	RO	Reserved	-	No	No	No
-	8965	-	-	RO	Reserved	-	No	No	No
-	8966	-	-	RO	Reserved	-	No	No	No
B7	8967	-	INT	RO	Out condensator temperature	1/10°C; 1/10°F	Yes	No	No
-	8968	-	-	RO	Reserved	-	No	No	No
-	8969	-	-	RO	Reserved	-	No	No	No
B10	8970	-	INT	RO	Electrical panel temperature (if fitted)	1/10°C; 1/10°F	No	Yes	Yes
P1	8971	-	INT	RO	Refrigerant high pressure side 1	1/10 Bar	No	Yes	Yes
P2	8972	-	INT	RO	Refrigerant high pressure side 2	1/10 Bar	No	No	Yes
LH20	8973	-	BOOL	RO	Low level water (if fitted - FALSE is OK)	X	Yes	Yes	Yes
OnOF	8974	-	BOOL	RO	Remote ON/OFF status request (TRUE is ON)	X	Yes	Yes	Yes
HPS1	8975	-	BOOL	RO	High pressure switch status side 1 (FALSE is OK)	X	Yes	Yes	Yes
HPS2	8976	-	BOOL	RO	High pressure switch status side 2 (FALSE is OK)	X	No	No	Yes
LPS1	8977	-	BOOL	RO	Low pressure switch status side 1 (FALSE is OK)	X	No	Yes	Yes
LPS2	8978	-	BOOL	RO	Low pressure switch status side 2 (FALSE is OK)	X	No	No	Yes
THP1	8979	-	BOOL	RO	Thermal pump 1 switch status (if fitted - FALSE is OK)	X	No	Yes	Yes
THP2	8980	-	BOOL	RO	Thermal pump 2 switch status (if fitted - FALSE is OK)	X	No	Yes	Yes
PHAS	8981	-	BOOL	RO	Sequence phase monioring (FALSE is OK)	X	No	Yes	Yes
THC1	8982	-	BOOL	RO	Thermal compressor 1 switch (if fitted - TRUE is OK)	X	No	Yes	Yes
THC2	8983	-	BOOL	RO	Thermal compressor 2 switch (if fitted - TRUE is OK)(from model 055-120)	X	No	Yes	Yes
CMP1	8984	-	BOOL	RO	Compressor 1 contactor (TRUE is ON)	X	Yes	Yes	Yes
FAN1	8985	-	BOOL	RO	Fan 1 contactor (TRUE is ON)	X	Yes	Yes	Yes
VAL1	8986	-	BOOL	RO	CPT valve 1 (if fitted - TRUE is open)	X	Yes	Yes	Yes
VAL2	8987	-	BOOL	RO	CPT valve 2 (if fitted - TRUE is open)	X	No	Yes	Yes
CMP2	8988	-	BOOL	RO	Compressor 2 contactor (TRUE is ON) (from model 055-120)	X	No	Yes	Yes
FAN2	8989	-	BOOL	RO	Fan 2 contactor (TRUE is ON)	X	No	Yes	Yes
PMP1	8990	-	BOOL	RO	Pump 1 contactor (if fitted - TRUE is ON)	X	Yes	Yes	Yes
ALRM	8991	-	BOOL	RO	Warning/Alarms relay status (TRUE is ON)	X	Yes	Yes	Yes
PSTA	8992	-	BOOL	RO	Status Chiller (TRUE if ON)	X	Yes	Yes	Yes
AOF	8993	-	BOOL	RO	Fan speed control (if fitted)	1/10%	Yes	Yes	Yes
HECA	8994	-	BOOL	RO	Cranckase heater (if fitted - TRUE is ON)	X	No	Yes	Yes
R QE	8995	-	BOOL	RO	Electrcal panel heater (if fitted - TRUE is ON)	X	No	Yes	Yes
AFHE	8996	-	BOOL	RO	Antifreeze heater (if fitted - TRUE is ON)	X	No	Yes	Yes
F QE	8997	-	BOOL	RO	Electrical panel fan (if fitted - TRUE is ON)	X	No	Yes	Yes
FAN3	8998	-	BOOL	RO	Fan 3 contactor (if fitted - TRUE is ON)	X	No	No	Yes
PMP2	8999	-	BOOL	RO	Pump 2 contactor (if fitted - TRUE is ON)	X	No	Yes	Yes
uA11	9000	-	WORD	RO	Alarm word	X	Yes	Yes	Yes
-	-	9001.0	BIT	RO	Pump 1 thermal protection	X	Yes	Yes	Yes
-	-	9001.1	BIT	RO	Pump 2 thermal protection	X	No	Yes	Yes
-	-	9001.2	BIT	RO	Low level water	X	Yes	Yes	Yes

Modbus

Tag	Adress		Type	Acces	Description	u.m.	ICEP-E 005	ICEP-E 008 / 065	ICEP-E 080/ 120
-	9001.3	BIT	RO	High temperature BT1 (if setted as alarm)	X	Yes	Yes	Yes	
-	9001.4	BIT	RO	Low temperature BT1	X	Yes	Yes	Yes	
-	9001.5	BIT	RO	High temperature BT2 (if setted as alarm)	X	Yes	Yes	Yes	
-	9001.6	BIT	RO	Low temperature BT2	X	Yes	Yes	Yes	
-	9001.7	BIT	RO	High temperature BT3 (if setted as alarm)	X	Yes	Yes	Yes	
-	9001.8	BIT	RO	Low temperature BT3	X	Yes	Yes	Yes	
-	9001.9	BIT	RO	Voltage phase and balancing monitoring	X	Yes	Yes	Yes	
-	9001.10	BIT	RO	I/O expansion	X	No	Yes	Yes	
-	9001.11	BIT	RO	Chiller configuration	X	Yes	Yes	Yes	
-	9001.12	BIT	RO	Probe BT1	X	Yes	Yes	Yes	
-	9001.13	BIT	RO	Probe BT2	X	Yes	Yes	Yes	
-	9001.14	BIT	RO	Probe BT3	X	Yes	Yes	Yes	
-	9001.15	BIT	RO	Reserved	-	No	No	No	
uAl2	9001	-	WORD	Warning word 1	X	Yes	Yes	Yes	
-	9001.0	BIT	RO	Probe BP1 fault	X	No	Yes	Yes	
-	9001.1	BIT	RO	Probe BP2 fault	X	No	No	Yes	
-	9001.2	BIT	RO	Probe BT7 fault	X	Yes	No	No	
-	9001.3	BIT	RO	High pessure switch circuit 1	X	Yes	Yes	Yes	
-	9001.4	BIT	RO	Low pessure switch circuit 1	X	No	Yes	Yes	
-	9001.5	BIT	RO	High pessure switch circuit 2	X	No	No	Yes	
-	9001.6	BIT	RO	Low pessure switch circuit 2	X	No	No	Yes	
-	9001.7	BIT	RO	Internal protection compressor 1	X	No	No	Yes	
-	9001.8	BIT	RO	Internal protection compressor 2	X	No	No	Yes	
-	9001.9	BIT	RO	Reserved	-	No	No	No	
-	9001.10	BIT	RO	Reserved	-	No	No	No	
-	9001.11	BIT	RO	Reserved	-	No	No	No	
-	9001.12	BIT	RO	Reserved	-	No	No	No	
-	9001.13	BIT	RO	Reserved	-	No	No	No	
-	9001.14	BIT	RO	Reserved	-	No	No	No	
-	9001.15	BIT	RO	Reserved	-	No	No	No	
uWn1	9002	-	WORD	Warning word 2	X	Yes	Yes	Yes	
-	9002.0	BIT	RO	High temperature BT1 (if setted - as warning)	X	Yes	Yes	Yes	
-	9002.1	BIT	RO	High temperature BT2 (if setted - as warning)	X	Yes	Yes	Yes	
-	9002.2	BIT	RO	High temperature BT3 (if setted - as warning)	X	Yes	Yes	Yes	
-	9002.3	BIT	RO	Service time elapsed	X	Yes	Yes	Yes	
-	9002.4	BIT	RO	Internal RTC error	X	Yes	Yes	Yes	
-	9002.5	BIT	RO	Reserved	-	No	No	No	
-	9002.6	BIT	RO	Reserved	-	No	No	No	
-	9002.7	BIT	RO	Reserved	-	No	No	No	
-	9002.8	BIT	RO	Reserved	-	No	No	No	
-	9002.9	BIT	RO	Reserved	-	No	No	No	
-	9002.10	BIT	RO	Reserved	-	No	No	No	
-	9002.11	BIT	RO	Reserved	-	No	No	No	
-	9002.12	BIT	RO	Reserved	-	No	No	No	
-	9002.13	BIT	RO	Reserved	-	No	No	No	
-	9002.14	BIT	RO	Reserved	-	No	No	No	
-	9002.15	BIT	RO	Reserved	-	No	No	No	
uIN	9003	-	WORD	Digital input word	X	Yes	Yes	Yes	
-	9003.0	BIT	RO	High pressure switch circuit 1	X	Yes	Yes	Yes	
-	9003.1	BIT	RO	Low level water switch	X	Yes	Yes	Yes	
-	9003.2	BIT	RO	Remote ON/OFF input	X	Yes	Yes	Yes	

Modbus

Tag	Adress		Type	Acces	Description	u.m.	ICEP-E 005	ICEP-E 008 / 065	ICEP-E 080/ 120
	-	9003.3	BIT	RO	Thermal protection pump 1 (if fitted)	X	Yes	Yes	Yes
	-	9003.4	BIT	RO	Internal protection compressor 1	X	No	No	Yes
	-	9003.5	BIT	RO	Voltage phase and balancing monitoring	X	No	Yes	Yes
	-	9003.6	BIT	RO	Low pressure switch circuit 1	X	No	Yes	Yes
	-	9003.7	BIT	RO	Thermal protection pump 2 (if fitted)	X	No	Yes	Yes
	-	9003.8	BIT	RO	Internal protection compressor 2 (if fitted)	X	No	No	Yes
	-	9003.9	BIT	RO	High pressure switch circuit 2	X	No	No	Yes
	-	9003.10	BIT	RO	Low pressure switch circuit 2	X	No	No	Yes
	-	9003.11	BIT	RO	Reserved	-	No	No	No
	-	9003.12	BIT	RO	Reserved	-	No	No	No
	-	9003.13	BIT	RO	Reserved	-	No	No	No
	-	9003.14	BIT	RO	Reserved	-	No	No	No
	-	9003.15	BIT	RO	Reserved	-	No	No	No
uOUT	9004	-	WORD	RO	Digital Output word	X	Yes	Yes	Yes
	-	9004.0	BIT	RO	Plant status	X	Yes	Yes	Yes
	-	9004.1	BIT	RO	Pump 1	X	Yes	Yes	Yes
	-	9004.2	BIT	RO	General alarm	X	Yes	Yes	Yes
	-	9004.3	BIT	RO	Compressor 1	X	Yes	Yes	Yes
	-	9004.4	BIT	RO	Fan 1	X	Yes	Yes	Yes
	-	9004.5	BIT	RO	Fan 2	X	No	Yes	Yes
	-	9004.6	BIT	RO	Compressor 2 (from model 055-120)	X	No	Yes	Yes
	-	9004.7	BIT	RO	Pump 2	X	No	Yes	Yes
	-	9004.8	BIT	RO	Cranckase heater	X	No	Yes	Yes
	-	9004.9	BIT	RO	Antifreeze heater	X	No	Yes	Yes
	-	9004.10	BIT	RO	Fan 3	X	No	No	Yes
	-	9004.11	BIT	RO	Electrical panel heater	X	No	Yes	Yes
	-	9004.12	BIT	RO	CPT valve 1	X	No	Yes	Yes
	-	9004.13	BIT	RO	CPT valve 2	X	No	Yes	Yes
	-	9004.14	BIT	RO	Reserved	-	No	No	No
	-	9004.15	BIT	RO	Reserved	-	No	No	No
RES	9005	-	INT	RW	Alarm reset from Modbus	X	Yes	Yes	Yes
SUP	9006	-	BOOL	RW	ON/OFF request from Modbus	X	Yes	Yes	Yes
DEF	9007	-	BOOL	RO	Set default parameters	X	Yes	Yes	Yes
UH	9008	-	UINT	RO	Unit working hours	h	Yes	Yes	Yes
UHL	9009	-	UINT	RO	Unit working hours x1000	x1000 h	Yes	Yes	Yes
UPH	9010	-	UINT	RO	Unit Partial working hours	h	Yes	Yes	Yes
UPHL	9011	-	UINT	RO	Unit Partial working hours x1000	x1000 h	Yes	Yes	Yes
CIH	9012	-	UINT	RO	Compressor 1 working hours	h	Yes	Yes	Yes
CIHL	9013	-	UINT	RO	Compressor 1 working hours x1000	x1000 h	Yes	Yes	Yes
C2H	9014	-	UINT	RO	Compressor 2 working hours (from model 055-120)	h	No	Yes	Yes
C2HL	9015	-	UINT	RO	Compressor 2 working hours x1000 (from model 055-120)	x1000 h	No	Yes	Yes
ER01	9016	-	USINT	RO	Alarm probe BT1	X	Yes	Yes	Yes
ER02	9017	-	USINT	RO	Alarm probe BT2	X	Yes	Yes	Yes
ER03	9018	-	USINT	RO	Alarm probe BT3	X	Yes	Yes	Yes
ER04	9019	-	USINT	RO	Alarm probe BT7	X	Yes	No	No
ER05	9020	-	USINT	RO	Alarm probe BT10	X	Yes	Yes	Yes
ER06	9021	-	USINT	RO	Alarm probe BP1	X	Yes	Yes	Yes
ER07	9022	-	USINT	RO	Alarm probe BP2	X	No	No	Yes
ER08	9023	-	USINT	RO	High pressure alarm circuit 1	X	Yes	Yes	Yes
ER09	9024	-	USINT	RO	Low pressure alarm circuit 1	X	Yes	Yes	Yes
ER10	9025	-	USINT	RO	High pressure alarm circuit 2	X	No	No	Yes

Modbus

Tag	Adress	Type	Acces	Description	u.m.	ICEP-E 005	ICEP-E 008 / 065	ICEP-E 080 / 120
ER11	9026	-	USINT	RO	Low pressure alarm circuit 2	X	No	Yes
ER12	9027	-	USINT	RO	High temperature BT1 alarm	X	Yes	Yes
ER13	9028	-	USINT	RO	Low temperature BT1 alarm	X	Yes	Yes
ER14	9029	-	USINT	RO	High temperature BT2 alarm	X	Yes	Yes
ER15	9030	-	USINT	RO	Low temperature BT2 alarm	X	Yes	Yes
ER16	9031	-	USINT	RO	High temperature BT3 alarm	X	Yes	Yes
ER17	9032	-	USINT	RO	Low temperature BT3 alarm	X	Yes	Yes
ER18	9033	-	USINT	RO	Internal protection compressor 1 alarm	X	No	Yes
ER19	9034	-	USINT	RO	Internal protection compressor 2 alarm	X	No	Yes
ER20	9035	-	USINT	RO	Motor pump 1 protection alarm	X	No	Yes
ER21	9036	-	USINT	RO	Motor pump 2 protection alarm	X	No	Yes
ER22	9037	-	USINT	RO	Low level water alarm	X	Yes	Yes
ER23	9038	-	USINT	RO	Phase monitoring alarm	X	No	Yes
ER24	9039	-	USINT	RO	I/O expansion alarm	X	No	Yes
ER25	9040	-	USINT	RO	Reserved	-	No	No
ER26	9041	-	USINT	RO	Reserved	-	No	No
ER27	9042	-	USINT	RO	Service time alarm	X	Yes	Yes
ER28	9043	-	USINT	RO	RTC alarm	X	Yes	Yes
ER29	9044	-	USINT	RO	Configuration alarm	X	Yes	Yes
Set	9045	-	INT	RW	Water set point	1/10°C; 1/10°F	Yes	Yes
Set Min	9046	-	INT	RO	Water set point min. value settable	1/10°C; 1/10°F	Yes	Yes
Set Max	9047	-	INT	RO	Water set point max. value settable	1/10°C; 1/10°F	Yes	Yes
dIF1	9048	-	INT	RW	Differential for compressor thermostating	1/10°C; 1/10°F	Yes	Yes
dIF1 Min	9049	-	INT	RO	Differential for compr. thermostating min. value settable	1/10°C; 1/10°F	Yes	Yes
dIF1 Max	9050	-	INT	RO	Differential for compr. thermostating max. value settable	1/10°C; 1/10°F	Yes	Yes
HA1	9051	-	INT	RO	BT1 high temperature alarm	1/10°C; 1/10°F	Yes	Yes
HA1 Min	9052	-	INT	RO	BT1 high temperature alarm min. value settable	1/10°C; 1/10°F	Yes	Yes
HA1 Max	9053	-	INT	RO	BT1 high temperature alarm max. value settable	1/10°C; 1/10°F	Yes	Yes
SFQE	9054	-	INT	RO	Set On fan inside the QE	1/10°C; 1/10°F	No	Yes
SFQE Min	9055	-	INT	RO	Set On fan inside the QE min. value settable	1/10°C; 1/10°F	No	Yes
SFQE Max	9056	-	INT	RO	Set On fan inside the QE max. value settable	1/10°C; 1/10°F	No	Yes
SRQE	9057	-	INT	RO	Set On Heater inside the QE	1/10°C; 1/10°F	No	Yes
SRQE Min	9058	-	INT	RO	Set On Heater inside the QE min. value settable	1/10°C; 1/10°F	No	Yes
SRQE Max	9059	-	INT	RO	Set On Heater inside the QE max. value settable	1/10°C; 1/10°F	No	Yes
D QE	9060	-	INT	RO	Differential for ON Heater/Fan thermostating	1/10°C; 1/10°F	No	Yes
D QE Min	9061	-	INT	RO	Differential for ON Heater/Fan thermostating Min.	1/10°C; 1/10°F	No	Yes
D QE Max	9062	-	INT	RO	Differential for ON Heater/Fan thermostating Max.	1/10°C; 1/10°F	No	Yes
dIF2	9063	-	INT	RW	Differential for CPT thermostating	1/10°C; 1/10°F	Yes	Yes
dIF2 Min	9064	-	INT	RO	Differential for CPT thermostating min. value settable	1/10°C; 1/10°F	Yes	Yes
dIF2 Max	9065	-	INT	RO	Differential for CPT thermostating max. value settable	1/10°C; 1/10°F	Yes	Yes
LIS	9066	-	INT	RO	Water Set point lower limit	1/10°C; 1/10°F	Yes	Yes
LIS Min	9067	-	INT	RO	Water Set point lower limit min. value settable	1/10°C; 1/10°F	Yes	Yes
LIS Max	9068	-	INT	RO	Water Set point lower limit max. value settable	1/10°C; 1/10°F	Yes	Yes
LA1	9069	-	INT	RW	BT1 low temperature alarm	1/10°C; 1/10°F	Yes	Yes
LA1 Min	9070	-	INT	RO	BT1 low temperature alarm min. value settable	1/10°C; 1/10°F	Yes	Yes
LA1 Max	9071	-	INT	RO	BT1 low temperature alarm max. value settable	1/10°C; 1/10°F	Yes	Yes
Db1	9072	-	INT	RW	BT1 low temperature alarm retrigger	1/10°C; 1/10°F	Yes	Yes
Db1 Min	9073	-	INT	RO	BT1 low temperature alarm retrigger min. value settable	1/10°C; 1/10°F	Yes	Yes
Db1 Max	9074	-	INT	RO	BT1 low temperature alarm retrigger max. value settable	1/10°C; 1/10°F	Yes	Yes
HA2	9075	-	INT	RW	BT2 high temperature alarm	1/10°C; 1/10°F	Yes	Yes
HA2 Min	9076	-	INT	RO	BT2 high temperature alarm min. value settable	1/10°C; 1/10°F	Yes	Yes

Modbus

Tag	Adress		Type	Acces	Description	u.m.	ICEP-E 005	ICEP-E 008 / 065	ICEP-E 080 / 120
HA2 Max	9077	-	INT	RO	BT2 high temperature alarm max. value settable	1/10°C; 1/10°F	Yes	Yes	Yes
LA2	9078	-	INT	RW	BT2 low temperature alarm	1/10°C; 1/10°F	Yes	Yes	Yes
LA2 Min	9079	-	INT	RO	BT2 low temperature alarm min. value settable	1/10°C; 1/10°F	Yes	Yes	Yes
LA2 Max	9080	-	INT	RO	BT2 low temperature alarm max. value settable	1/10°C; 1/10°F	Yes	Yes	Yes
HA3	9081	-	INT	RW	BT3 high temperature alarm	1/10°C; 1/10°F	Yes	Yes	Yes
HA3 Min	9082	-	INT	RO	BT3 high temperature alarm min. value settable	1/10°C; 1/10°F	Yes	Yes	Yes
HA3 Max	9083	-	INT	RO	BT3 high temperature alarm max. value settable	1/10°C; 1/10°F	Yes	Yes	Yes
LA3	9084	-	INT	RW	BT3 low temperature alarm	1/10°C; 1/10°F	Yes	Yes	Yes
LA3 Min	9085	-	INT	RO	BT3 low temperature alarm min. value settable	1/10°C; 1/10°F	Yes	Yes	Yes
LA3 Max	9086	-	INT	RO	BT3 low temperature alarm max. value settable	1/10°C; 1/10°F	Yes	Yes	Yes
SEA	9087	-	INT	RW	BT1 set point antifreeze	1/10°C; 1/10°F	Yes	Yes	Yes
SEA Min	9088	-	INT	RO	BT1 set point antifreeze min. value settable	1/10°C; 1/10°F	Yes	Yes	Yes
SEA Max	9089	-	INT	RO	BT1 set point antifreeze max. value settable	1/10°C; 1/10°F	Yes	Yes	Yes
DIA	9090	-	INT	RW	BT1 thermostatic differential	1/10°C; 1/10°F	Yes	Yes	Yes
DIA Min	9091	-	INT	RO	BT1 thermostatic differential min. value settable	1/10°C; 1/10°F	Yes	Yes	Yes
DIA Max	9092	-	INT	RO	BT1 thermostatic differential max. value settable	1/10°C; 1/10°F	Yes	Yes	Yes
ARA	9093	-	INT	RW	BT3 set point activation	1/10°C; 1/10°F	Yes	Yes	Yes
ARA Min	9094	-	INT	RO	BT3 set point activation min. value settable	1/10°C; 1/10°F	Yes	Yes	Yes
ARA Max	9095	-	INT	RO	BT3 set point activation max. value settable	1/10°C; 1/10°F	Yes	Yes	Yes
DtHA	9096	-	INT	RW	Differential for dipendet water exit value	1/10°C; 1/10°F	Yes	Yes	Yes
DtHA Min	9097	-	INT	RO	Differential for dipendet water exit value min. v.s.	1/10°C; 1/10°F	Yes	Yes	Yes
DtHA Max	9098	-	INT	RO	Differential for dipendet water exit value max. v.s.	1/10°C; 1/10°F	Yes	Yes	Yes
DMIN	9099	-	INT	RW	Min value to run compressor in ERD	1/10°C; 1/10°F	Yes	Yes	Yes
DMIN Min	9100	-	INT	RO	Min value to run compressor in ERD value min. v.s.	1/10°C; 1/10°F	Yes	Yes	Yes
DMIN Max	9101	-	INT	RO	Min value to run compressor in ERD value max. v.s.	1/10°C; 1/10°F	Yes	Yes	Yes
DMAX	9102	-	INT	RW	Max value to run compressor in ERD	1/10°C; 1/10°F	Yes	Yes	Yes
DMAX Min	9103	-	INT	RO	Max value to run compressor in ERD value min. v.s.	1/10°C; 1/10°F	Yes	Yes	Yes
DMAX Max	9104	-	INT	RO	Max value to run compressor in ERD value max. v.s.	X	Yes	Yes	Yes
HysP	9105	-	INT	RW	Historical Record: 0= Most recent / 39 = Oldest	X	Yes	Yes	Yes
HysC	9106	-	INT	RO	Historical Alarm code	X	Yes	Yes	Yes
Hysd	9107	-	INT	RO	Historical Alarm date	X	Yes	Yes	Yes
Hyst	9108	-	INT	RO	Historical Alarm time	X	Yes	Yes	Yes
HUSS	9109	-	INT	RO	Historical Alarm time	X	Yes	Yes	Yes
HUSSt	9110	-	INT	RO	Historical Alarm time	X	Yes	Yes	Yes
HUSE	9111	-	INT	RO	Historical Alarm time	X	Yes	Yes	Yes
Hys1	9112	-	INT	RO	Historical Alarm B1 value	X	Yes	Yes	Yes
Hys2	9113	-	INT	RO	Historical Alarm B2 value	X	Yes	Yes	Yes
Hys3	9114	-	INT	RO	Historical Alarm SET value	X	Yes	Yes	Yes
HysF	9115	-	UINT	RO	Historical Number of records	X	Yes	Yes	Yes
A1	16384	-	BOOL	RW	Unit of measure (False = °C; True = °F)	X	Yes	Yes	Yes
A7	16385	-	USINT	RW	Enable remote ON/OFF hard wiring	X	Yes	Yes	Yes
CFJ1	16386	-	USINT	RW	ALarm relay managment	X	Yes	Yes	Yes
SUP	16387	-	BOOL	RW	Enable remote ON/OFF modbus	X	Yes	Yes	Yes
-	16388	-	-	RO	Reserved	-	No	No	No
-	16389	-	-	RO	Reserved	-	No	No	No
AST	16390	-	-	RO	Autostart enable	X	Yes	Yes	Yes

7.5 Dimensional drawings ICEP008-015E

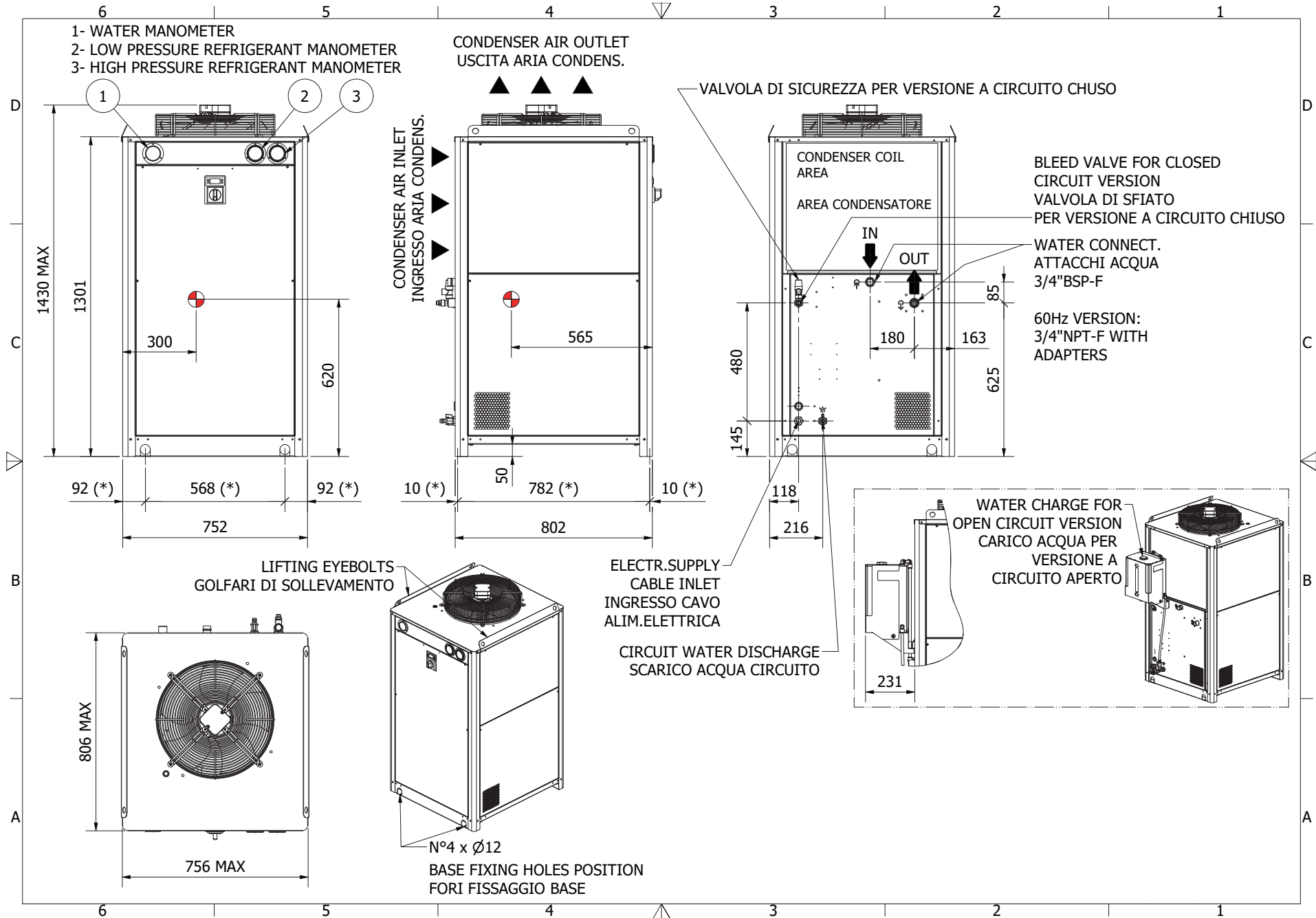

Dimensional drawings ICEP022E

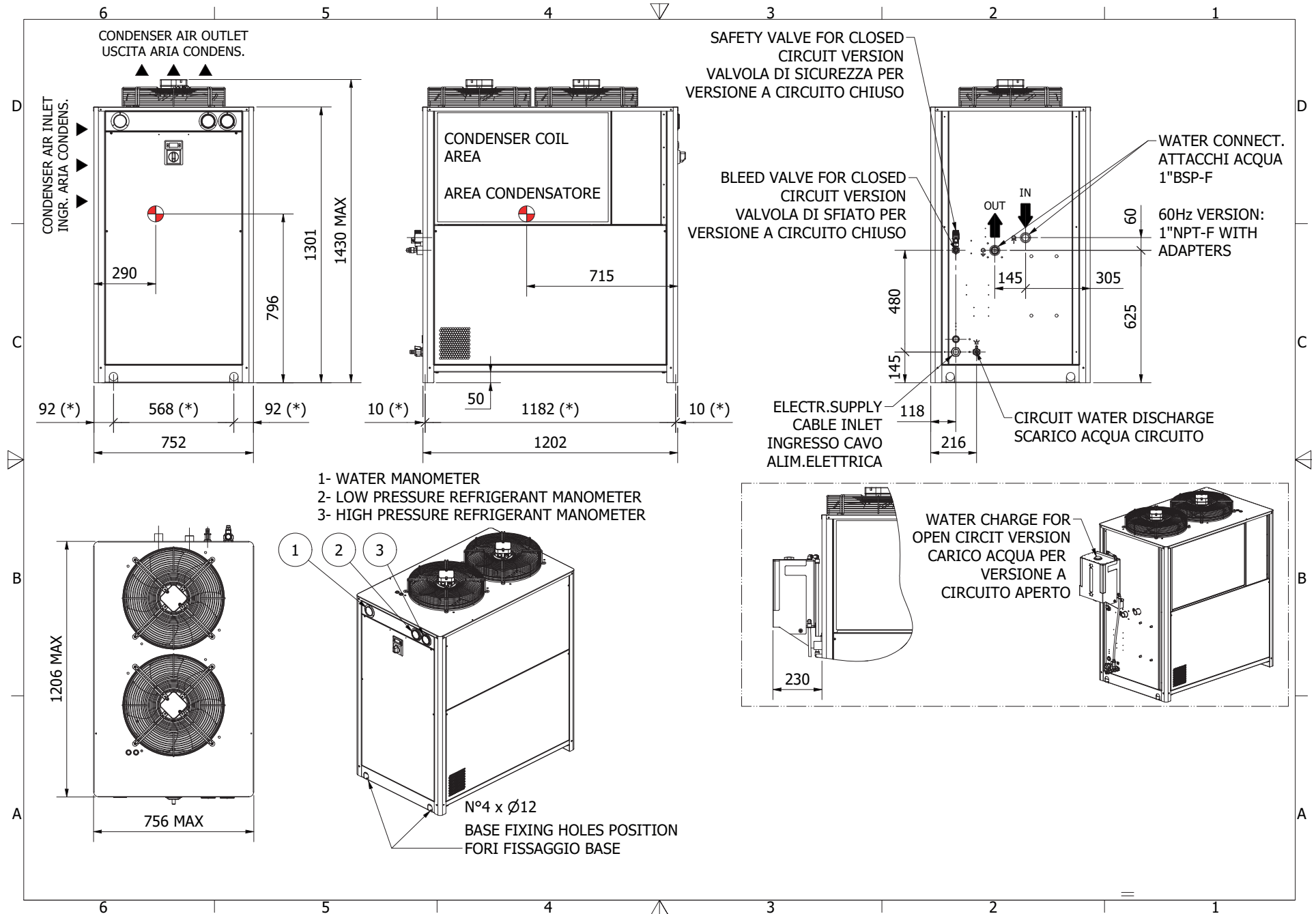

Dimensional drawings ICEP027E

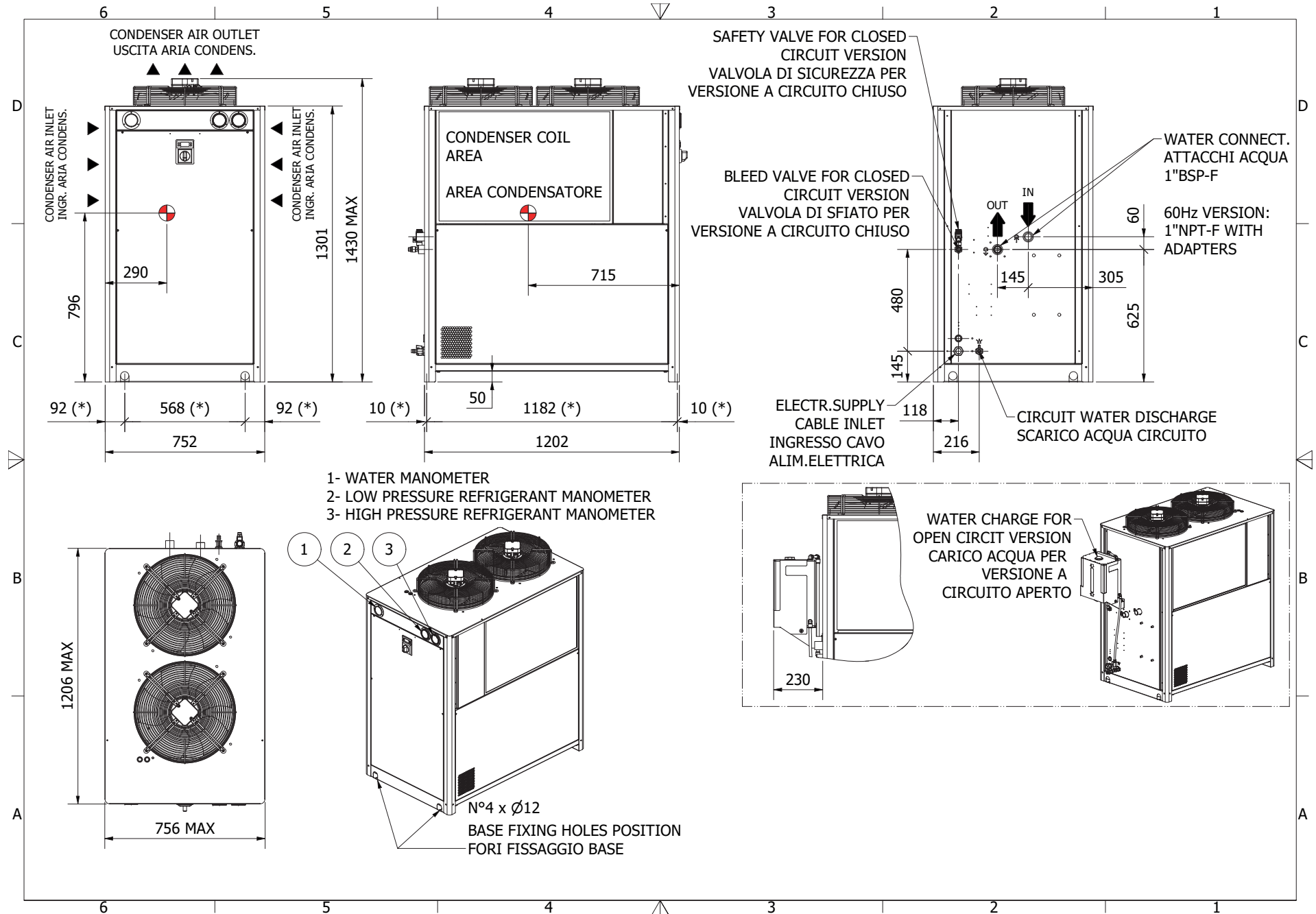

Dimensional drawings - External tank

MANUAL

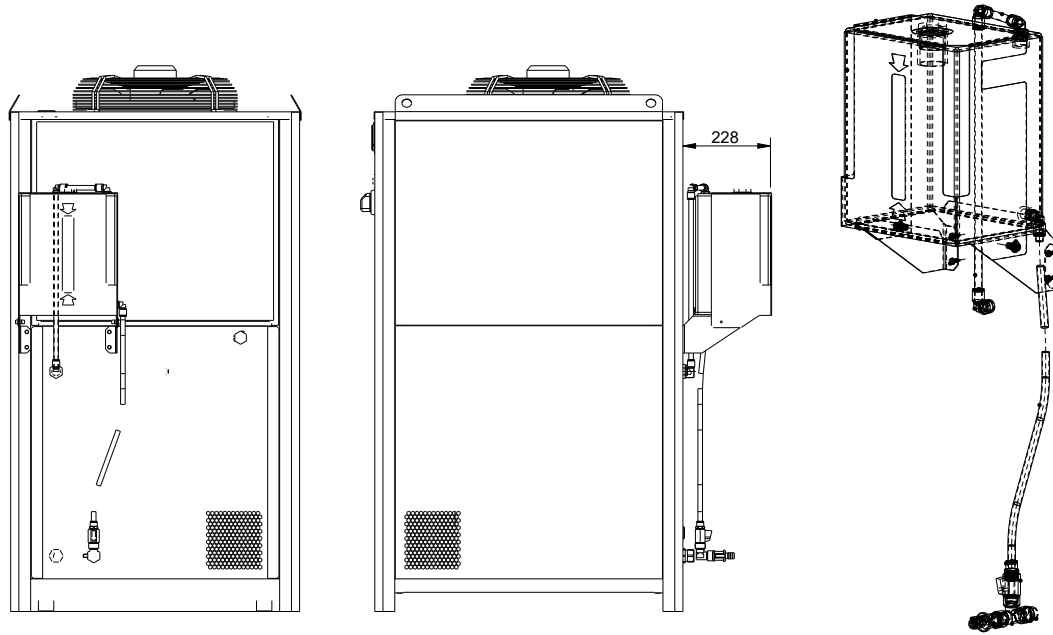

AUTOMATIC

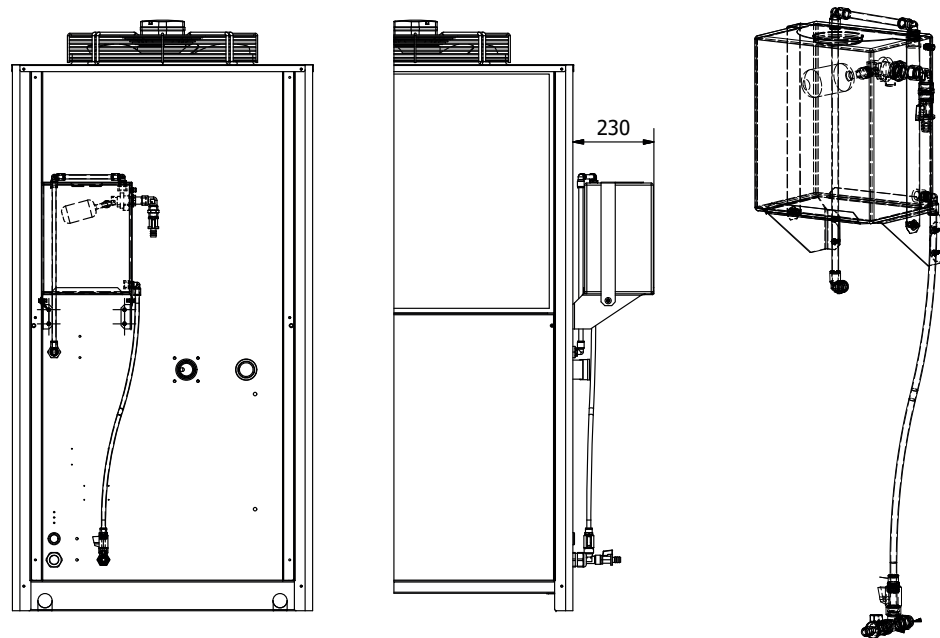

7.6 Spare parts

COMPONENT	(7.4 / 7.5)	ICEP008E	ICEP011E	ICEP015E	ICEP022E	ICEP027E
Electrical kit	-	398H473803			398H473804	
Compressor kit	① ④ KM1	398H473760	398H473762	398H473764	398H473616	398H473768
Fan kit	③ KM5	On request		On request		
Expansion valve kit	④ ⑤	398H473808	398H473809	398H473810	398H473811	398H473812
Plate type heat exchanger kit	⑥	398H473628	398H473629	398H473630	398H473631	398H473632
Pump kit P30 (3 barg)	⑦ KM7	On request		On request	On request	
Pump kit P15 (1.5 barg)		/	/	/	/	/
Pump kit P50 (5 barg)		On request		On request		On request
Tank kit	⑧	398H473580			398H473581	
Refrigerant condenser	②	ET-398H114849			ET-398H114852	ET-398H114839
Refrigerant filter	④	398H206226			ET-398H2062257	
Water manometer	⑪	398H354031				
Water outlet temperature sensor	⑬	398H275894				
Evaporator temperature sensor (anti-freeze)	⑭	398H275894				
Water level sensor	⑮	398H275924				
Electronic control	A1⑯	398H473649				
Differential water pressure switch	⑰	398H354136				
High pressure switch	⑱	ET-398H474520				
Low pressure switch	⑲	ET-398H474521				
Low pressure side manometer	⑳	398H354042				
High pressure side manometer	㉑	398H354042				
Coil (Hot gas valve)	㉒ ㉓	398H254009				

7.6 Spare parts

COMPONENT	(7.4 / 7.5)	ICEP008E	ICEP011E	ICEP015E	ICEP022E	ICEP027E
Sight glass	②4	ET-398H348008			ET-398H348007	
High pressure trasmitter	②5	398H275311				
Ambient temperature sensor	②6	398H275233				
No return valve kit	②8	-			398H785321	
Main switch	QS1	398H256418			398H256422	
Auxliary transformer	TC1	on request			on request	
Phase monitor	FV1	398H256366				

7.7 Exploded drawing ICEP008-011-015E

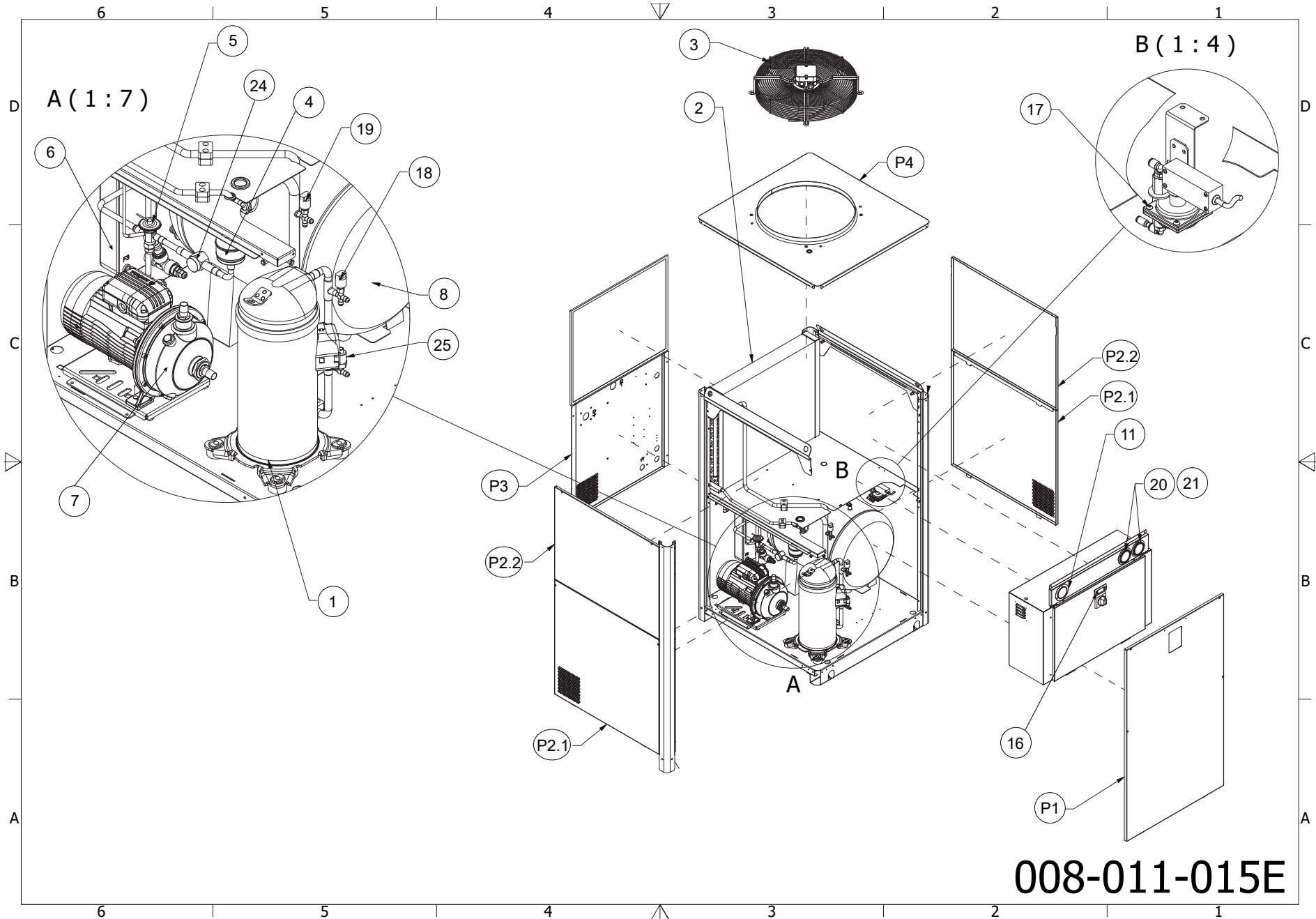

Exploded drawing ICEP022E

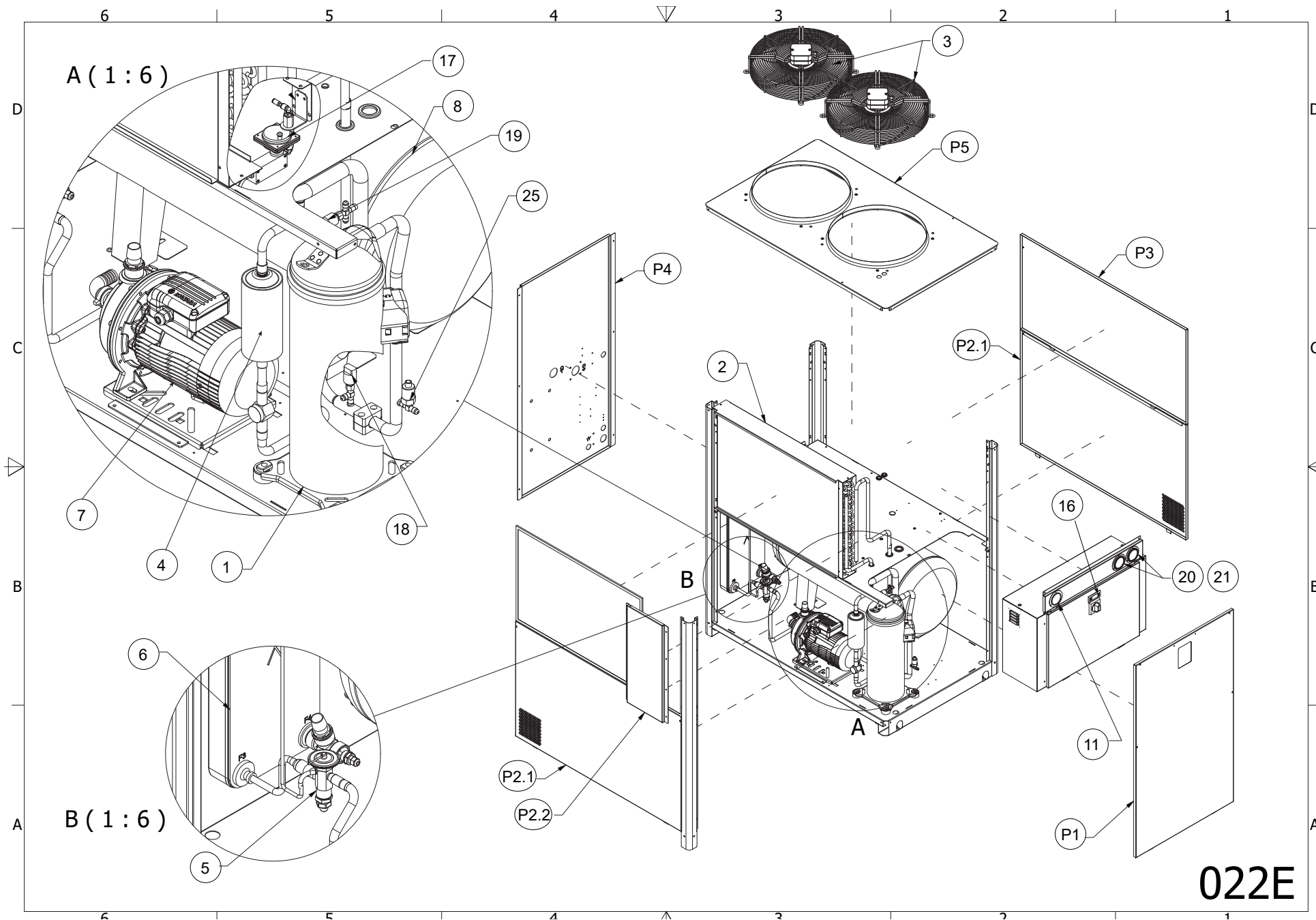

022E

Exploded drawing ICEP027E

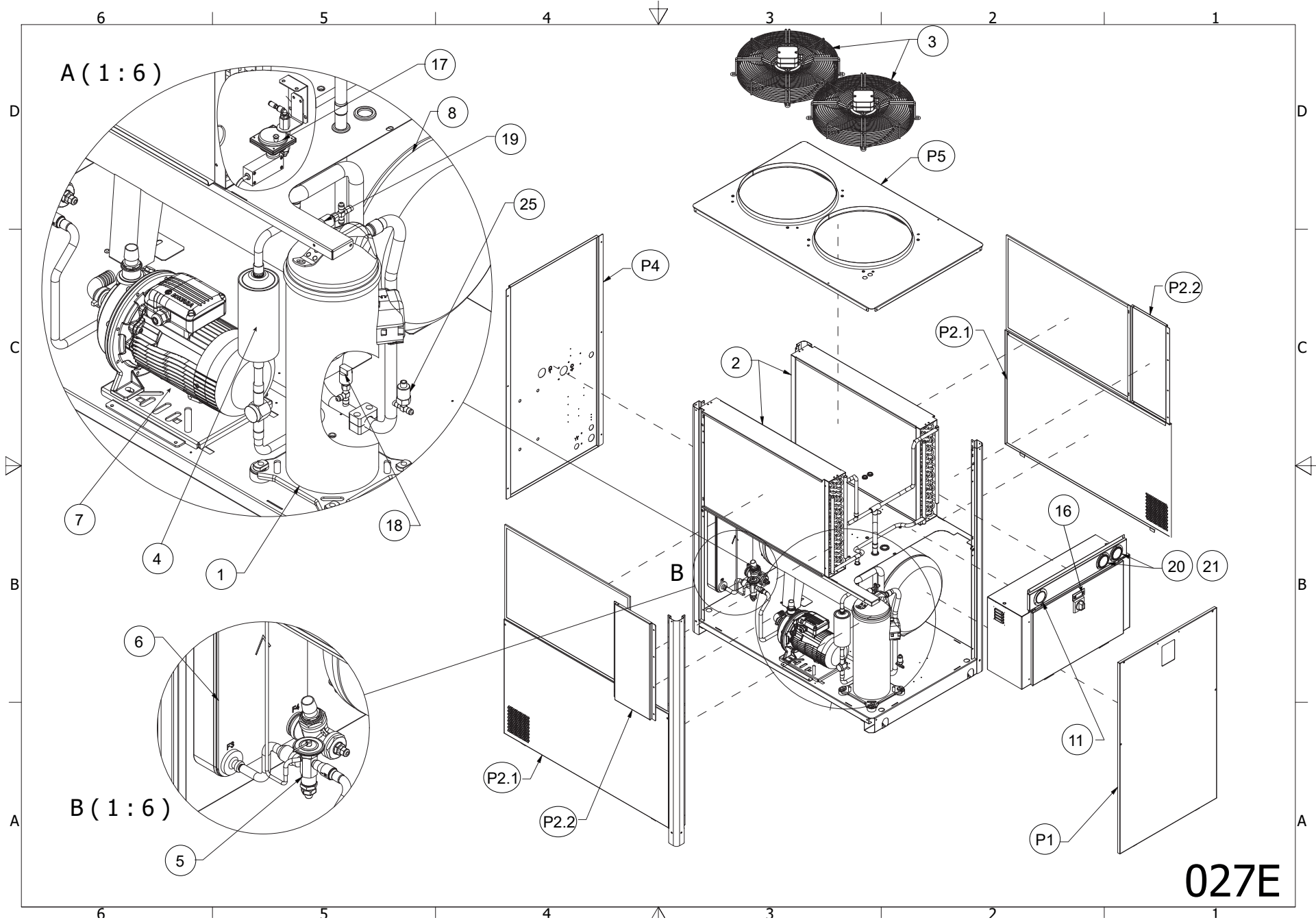

027E

7.8 Circuit Diagram ICEP008-015E

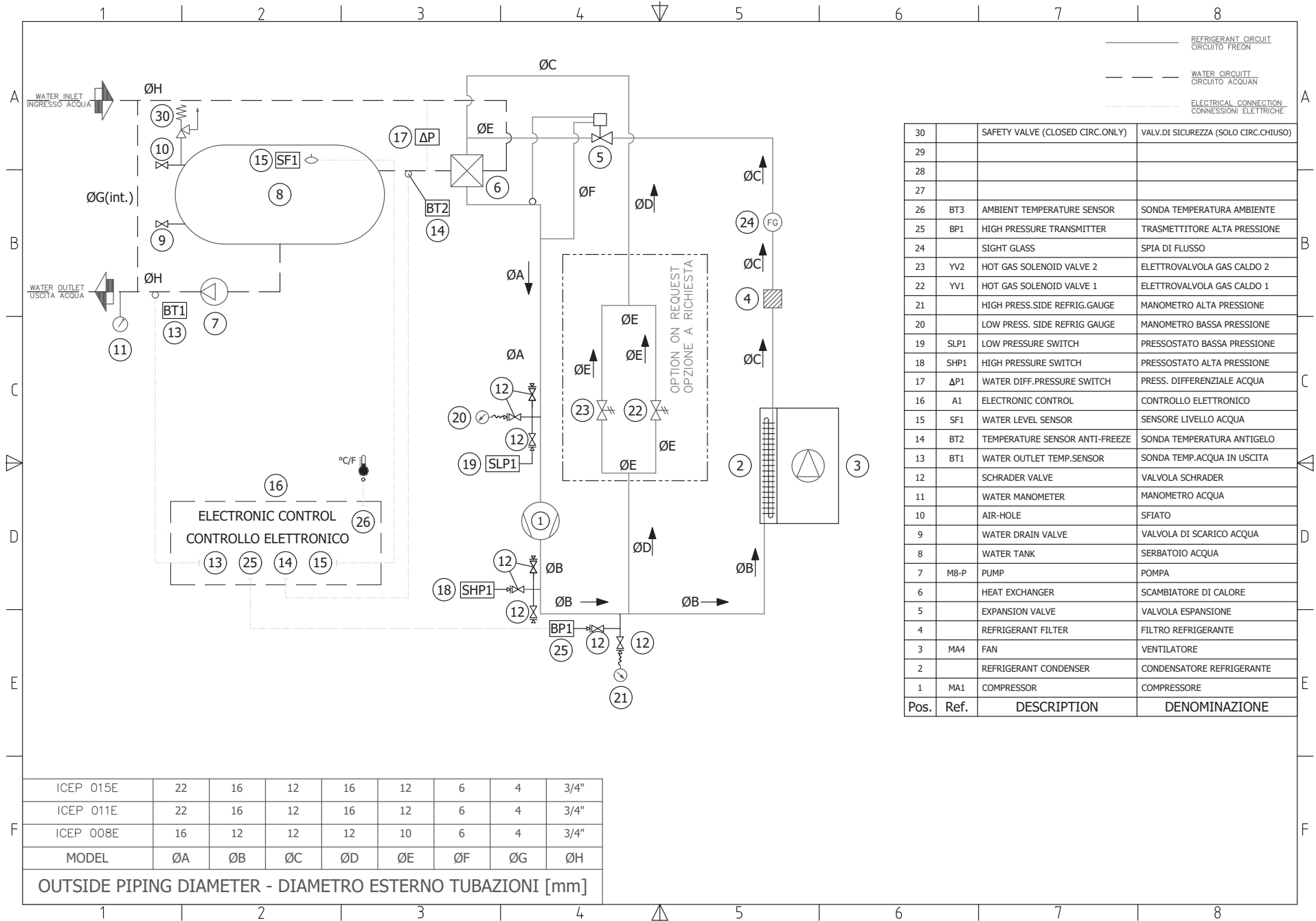

Circuit Diagram ICEP022E

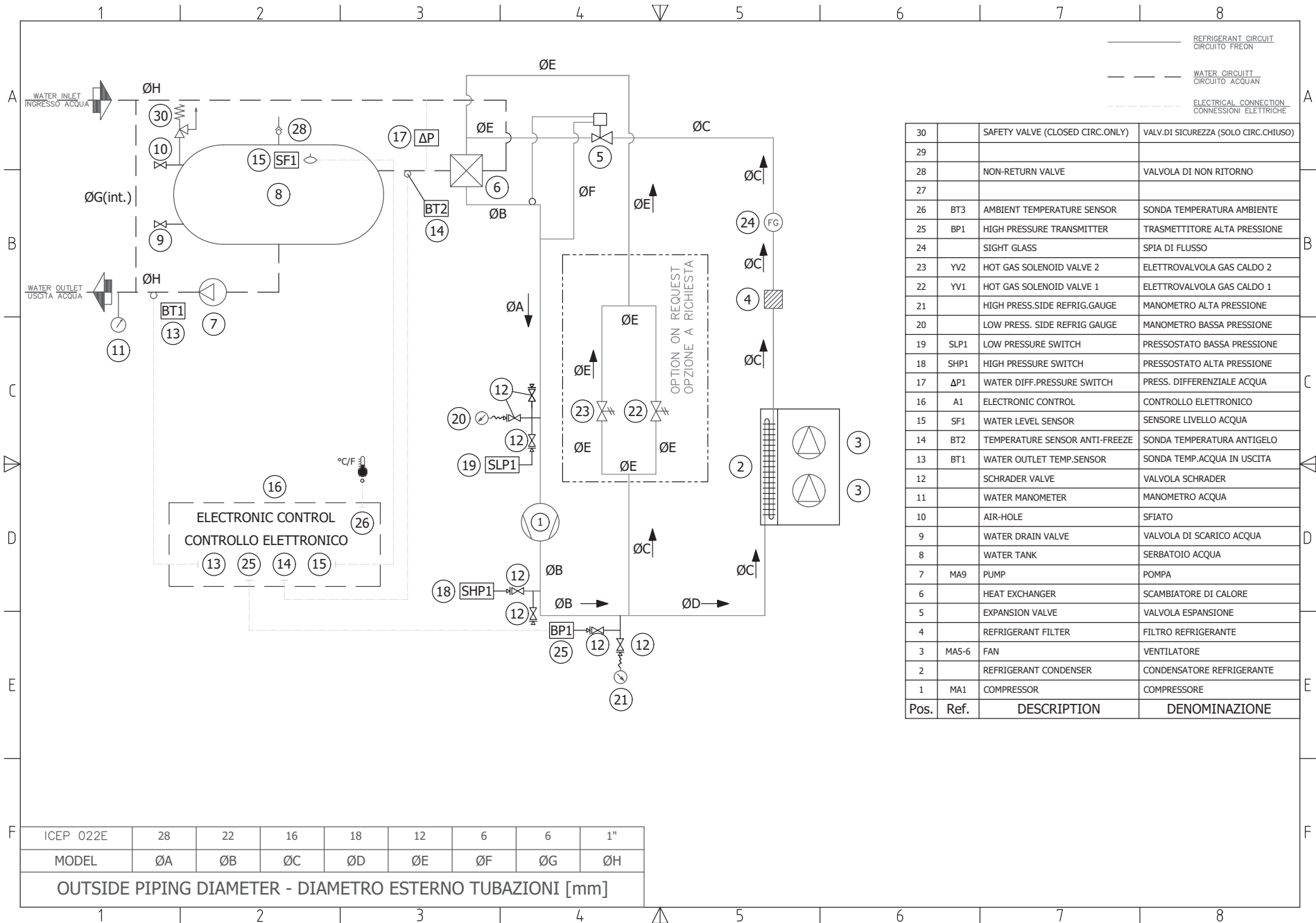

Circuit Diagram ICEP027E

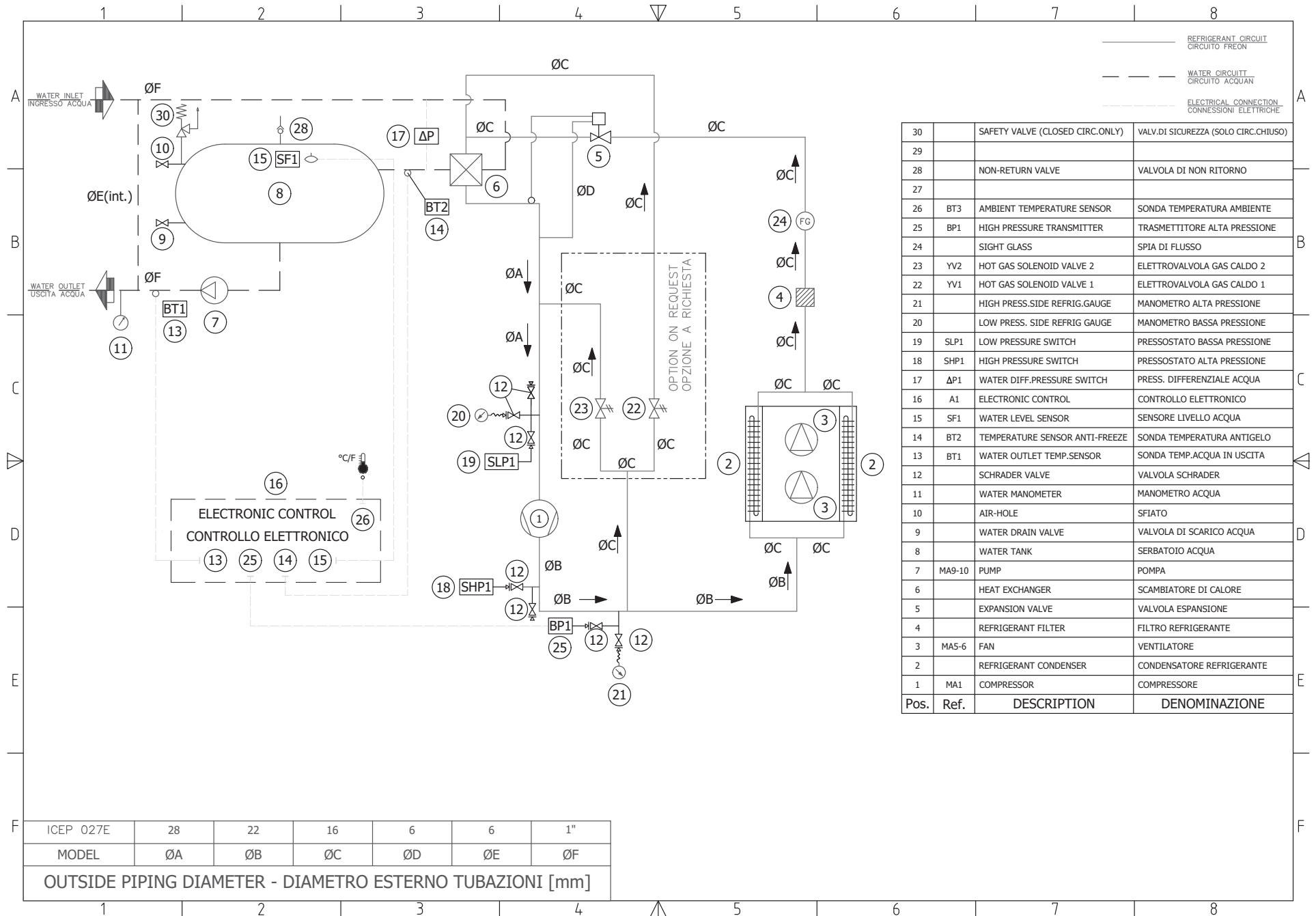

7.9 Wiring diagram ICEP008-015E (standard)

Sheet 1/15

MODEL MODELLO ICEP008	NOMINAL VOLTAGE TENSIONE NOMINALE Un (V) = 460				PHASES FASI Ph = 3				FREQUENCY FREQUENZA f (Hz) = 60				NOMINAL VOLTAGE TENSIONE NOMINALE Un (V) = 460				PHASES FASI Ph = 3				FREQUENCY FREQUENZA f (Hz) = 60				NOMINAL VOLTAGE TENSIONE NOMINALE Un (V) = 460V/3/60Hz					
	COMPRESSORS COMPRESSORI				FAN MOTOR ELETTROVENTILATORE				PUMP POMPA				MODEL - MODELLI ICEP008																	
	SIGLA	FLA (A)	KW	LRA (A)	SIGLA	FLA (A)	KW	LRA (A)	SIGLA	FLA (A)	KW	LRA (A)	MCA (A)	MOP (A)	FLA (A) Tot.															
	M1- MC1	6.1	2.82 (5HP)	45	M2-EV1	0.35	0.57 [3/4 HP]	1.75	M9-P1(P15)	/	/	/	/	/	/	M9-P1 (P30)	1.2	λ	0.5 [3/4 HP]	5.93	9.5	15	7.65	M9-P1(P50)	1.81	λ	0.75 [1 HP]	14.93	10	15

MODEL MODELLO ICEP011	NOMINAL VOLTAGE TENSIONE NOMINALE Un (V) = 460				PHASES FASI Ph = 3				FREQUENCY FREQUENZA f (Hz) = 60				NOMINAL VOLTAGE TENSIONE NOMINALE Un (V) = 460				PHASES FASI Ph = 3				FREQUENCY FREQUENZA f (Hz) = 60				NOMINAL VOLTAGE TENSIONE NOMINALE Un (V) = 460V/3/60Hz					
	COMPRESSORS COMPRESSORI				FAN MOTOR ELETTROVENTILATORE				PUMP POMPA				MODEL - MODELLI ICEP011																	
	SIGLA	FLA (A)	KW	LRA (A)	SIGLA	FLA (A)	KW	LRA (A)	SIGLA	FLA (A)	KW	LRA (A)	MCA (A)	MOP (A)	FLA (A) Tot.															
	M1- MC1	8.3	4.01 (7.5HP)	60	M2-EV1	0.35	0.57 [3/4 HP]	1.75	M9-P1(P15)	/	/	/	/	/	/	M9-P1(P30)	1.2	λ	0.5 [3/4 HP]	5.93	12	20	9.85	M9-P1(P50)	1.81	λ	0.75 [1 HP]	14.93	13	20

MODEL MODELLO ICEP015	NOMINAL VOLTAGE TENSIONE NOMINALE Un (V) = 460				PHASES FASI Ph = 3				FREQUENCY FREQUENZA f (Hz) = 60				NOMINAL VOLTAGE TENSIONE NOMINALE Un (V) = 460				PHASES FASI Ph = 3				FREQUENCY FREQUENZA f (Hz) = 60				NOMINAL VOLTAGE TENSIONE NOMINALE Un (V) = 460V/3/60Hz					
	COMPRESSORS COMPRESSORI				FAN MOTOR ELETTROVENTILATORE				PUMP POMPA				MODEL - MODELLI ICEP015																	
	SIGLA	FLA (A)	KW	LRA (A)	SIGLA	FLA (A)	KW	LRA (A)	SIGLA	FLA (A)	KW	LRA (A)	MCA (A)	MOP (A)	FLA (A) Tot.															
	M1- MC1	9.6	6.1 (7.5HP)	82	M2-EV1	1.02	0.71 [1 HP]	5.1	M9-P1(P15)	/	/	/	/	/	/	M9-P1(P30)	1.13	λ	0.5 [3/4 HP]	5.58	14.5	20	11.75	M9-P1(P50)	2.42	λ	1.1 [1.5 HP]	22.05	15.5	25

FOLGIO/SHEET	DESCRIZIONE	DESCRIPTION
1	Dati Tecnici	Technical Data
2	Dati Tecnici	Technical Data
3	Circuito di Potenza	Power Circuit
4	Circuito di Potenza	Power Circuit
5	Circuito Ausiliario	Auxiliary Circuit
6	Circuito Ausiliario	Auxiliary Circuit
7	Circuito Ausiliario	Auxiliary Circuit
8	Modulo Espansione	Expansion Module
9	Modulo Espansione	Expansion Module
10	Modulo Espansione	Expansion Module
11	Contatti Cliente	Terminal Block for User
12	Collegamenti Opzionali	Optional Terminal Block
13	Collegamenti Opzionali	Optional Terminal Block
14	Morsettiere	Terminal Block
15	Planimetria Quadro Elettrico	Electrical Lay-Out
16	Lista Componenti	Component List
17	Lista Componenti	Component List
18	Lista Componenti	Component List
19	Lista Componenti	Component List
20	Lista Componenti Parker	Component List - Parker
21	Lista Componenti Parker	Component List - Parker

Model	Cod.
ICEP008-E	398H316451
ICEP011-E	398H316452
ICEP015-E	398H316453

7.9 Wiring diagram ICEP008-015E (standard)

Sheet 2/15

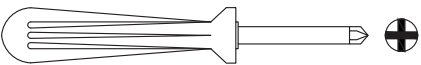
	1	2	3	4	5	6	7	8																								
A	SUPPLY VOLTAGE TENSIONE ALIMENTAZIONE		460V 3Ph 60Hz																													
	CONTROL VOLTAGE TENSIONE AUSILIARI		0-24 VAC / 0-230 VAC																													
	ENCLOSED TYPE PROTEZIONE IP		IP54																													
	RESIDUAL CURRENT SWITCH INTER. AUTOMATICO DIFFERENZIALE		RCBO Id=0,03A CLASS A																													
B	SCCR		--																													
	GROUNDING MESSA A TERRA		Solidly grounded																													
	CABLES SIZE SUPPLY CAVI INGRESSO ALIMENTAZIONE		See Table (MCA)																													
C																																
D	Tightening Torque			TABELLA COLORI CAVI - TABLE ELECTRICAL CABLES (Norme ANSI)																												
				<table border="1"> <thead> <tr> <th>Color</th> <th>Code</th> <th>Description</th> </tr> </thead> <tbody> <tr> <td>NERO - BLACK</td> <td>BK</td> <td>Conduttore di Potenza Principale in AC/DC - Main Power Circuits AC and DC</td> </tr> <tr> <td>AZZURRO - LIGHT BLUE</td> <td>BU</td> <td>Conduttore di Neutro - Neutral Conductor</td> </tr> <tr> <td>ROSSO - RED</td> <td>RD</td> <td>Circuiti di Comando in Corrente Alternata AC 12-24-230VAC - Control Circuits in AC 12-24-230VAC</td> </tr> <tr> <td>BLU SCURO - DARK BLUE</td> <td>DBU</td> <td>Circuiti di Comando in Corrente Continua DC 24VDC - Control Circuits in DC 24VDC</td> </tr> <tr> <td>ARANCIONE - ORANGE</td> <td>OG</td> <td>Circuiti Segnali in Tensione - Voltage Signal Circuits</td> </tr> <tr> <td>BIANCO - WHITE</td> <td>WH</td> <td>Circuiti di Misura - Measuring Circuits</td> </tr> <tr> <td>GIALLO-VERDE</td> <td>GNYE</td> <td>Conduttore di Terra - Grounded Conductors</td> </tr> </tbody> </table>					Color	Code	Description	NERO - BLACK	BK	Conduttore di Potenza Principale in AC/DC - Main Power Circuits AC and DC	AZZURRO - LIGHT BLUE	BU	Conduttore di Neutro - Neutral Conductor	ROSSO - RED	RD	Circuiti di Comando in Corrente Alternata AC 12-24-230VAC - Control Circuits in AC 12-24-230VAC	BLU SCURO - DARK BLUE	DBU	Circuiti di Comando in Corrente Continua DC 24VDC - Control Circuits in DC 24VDC	ARANCIONE - ORANGE	OG	Circuiti Segnali in Tensione - Voltage Signal Circuits	BIANCO - WHITE	WH	Circuiti di Misura - Measuring Circuits	GIALLO-VERDE	GNYE	Conduttore di Terra - Grounded Conductors
Color	Code	Description																														
NERO - BLACK	BK	Conduttore di Potenza Principale in AC/DC - Main Power Circuits AC and DC																														
AZZURRO - LIGHT BLUE	BU	Conduttore di Neutro - Neutral Conductor																														
ROSSO - RED	RD	Circuiti di Comando in Corrente Alternata AC 12-24-230VAC - Control Circuits in AC 12-24-230VAC																														
BLU SCURO - DARK BLUE	DBU	Circuiti di Comando in Corrente Continua DC 24VDC - Control Circuits in DC 24VDC																														
ARANCIONE - ORANGE	OG	Circuiti Segnali in Tensione - Voltage Signal Circuits																														
BIANCO - WHITE	WH	Circuiti di Misura - Measuring Circuits																														
GIALLO-VERDE	GNYE	Conduttore di Terra - Grounded Conductors																														
	Component	Nm	Lb*In																													
	3RV2011-1HA15	4,5000	40																													
	3RV2011-4JA15	4,5000	40																													
	3RV2011-4KA15	4,5000	40																													
E	OT25F3	0,8000	7,0000																													
	BCH	2,5000	22,0000																													
	M4_8SFL	0,8000	7,0000																													
	FV1	0,5000	4,4000																													
F																																

7.9 Wiring diagram ICEP008-015E (standard)

Sheet 3/15

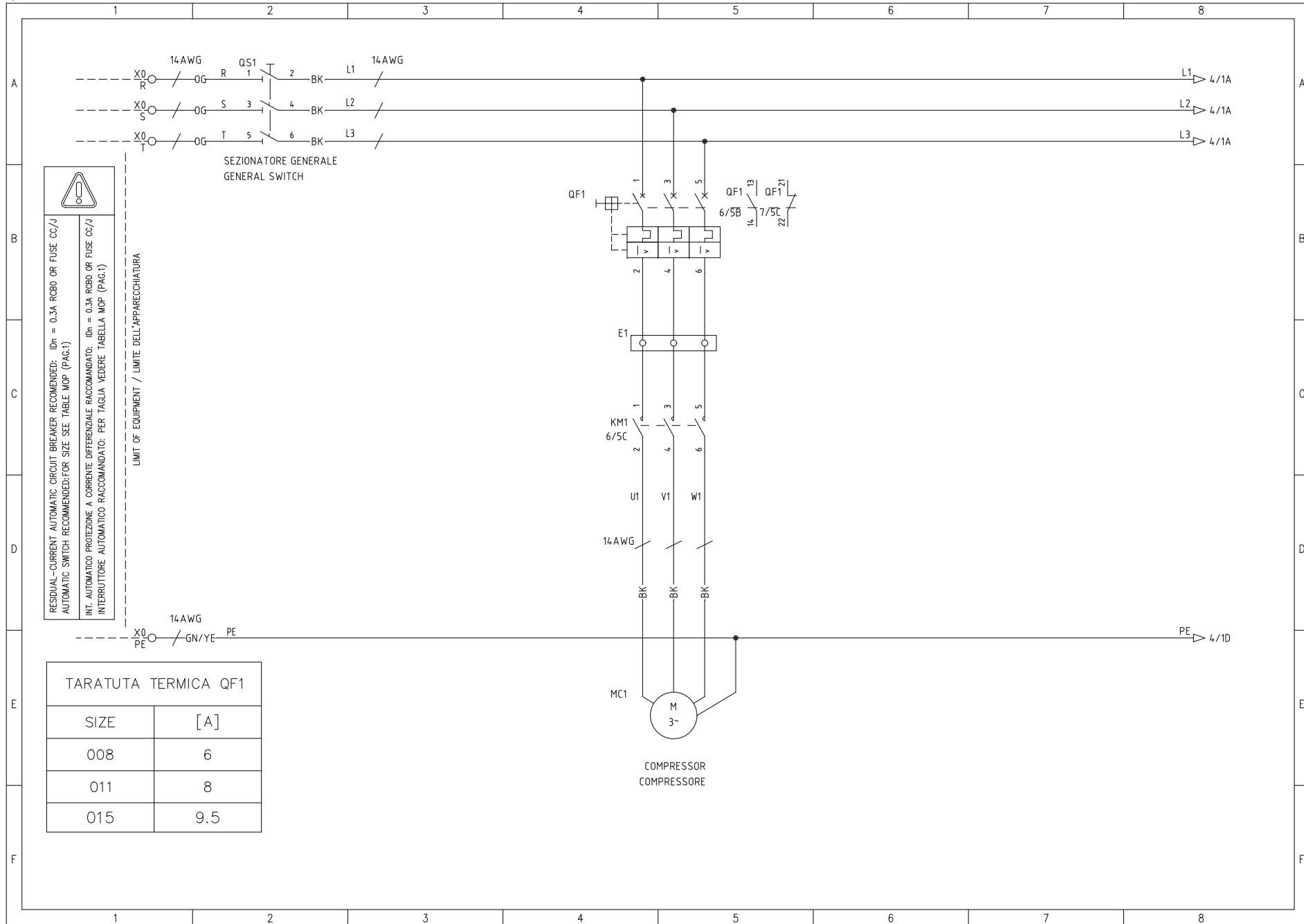

RESIDUAL-CURRENT AUTOMATIC CIRCUIT BREAKER RECOMMENDED: $I_{dn} = 0.3A$ RCBO OR FUSE CC/J
 AUTOMATIC SWITCH RECOMMENDED: FOR SIZE SEE TABLE MOP (PAG.1)
 INT. AUTOMATICO PROTEZIONE A CORRENTE DIFFERENZIALE RACCOMANDATO: $I_{dn} = 0.3A$ RCBO OR FUSE CC/J
 INTERRUPTORE AUTOMATICO RACCOMANDATO: PER TAGLIA VEDERE TABELLA MOP (PAG.1)

LIMIT OF EQUIPMENT / LIMITE DELL'APPARECCHIATURA

TARATURA TERMICA QF1	
SIZE	[A]
008	6
011	8
015	9.5

7.9 Wiring diagram ICEP008-015E (standard)

Sheet 4/15

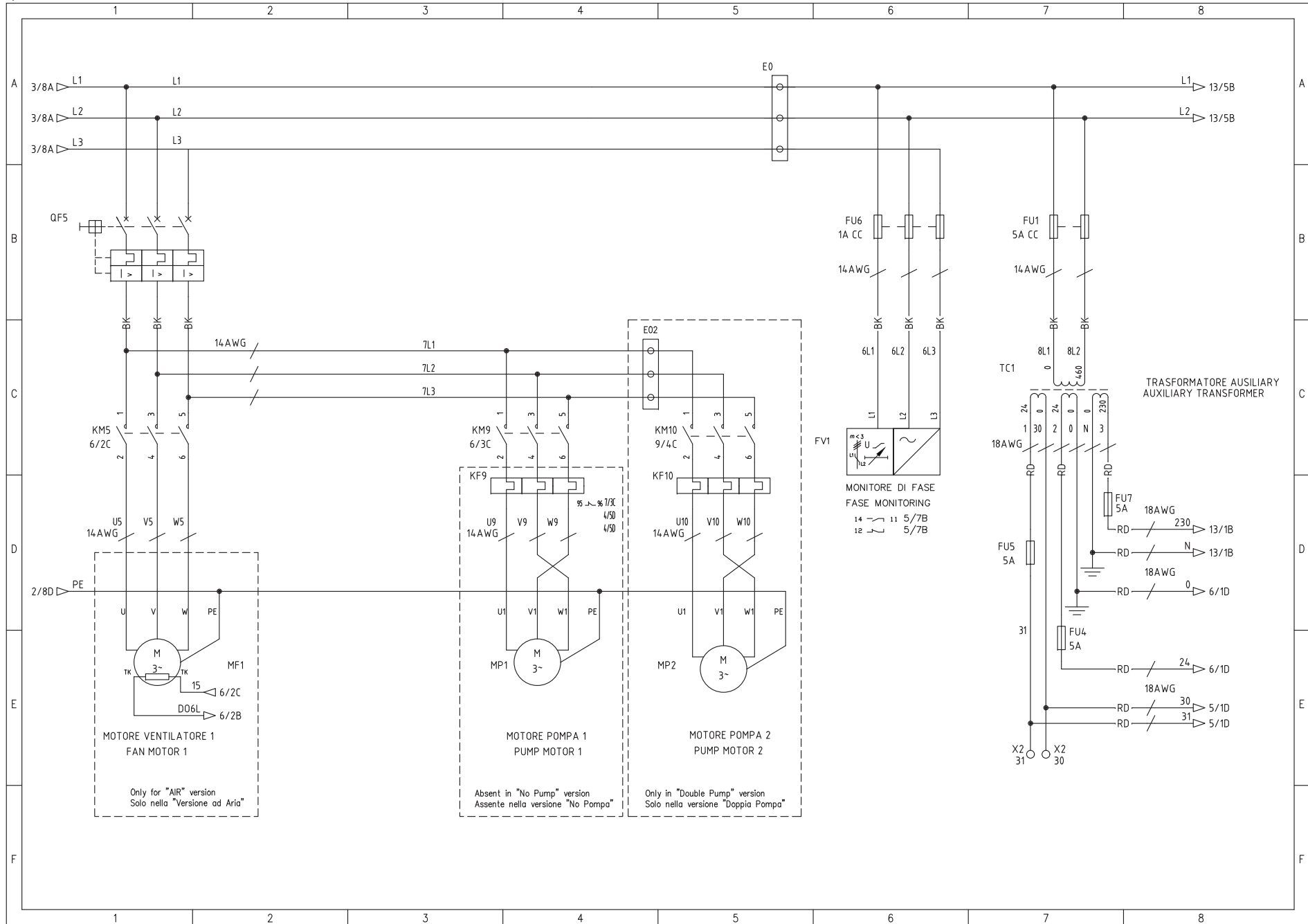

7.9 Wiring diagram ICEP008-015E (standard)

Sheet 5/15

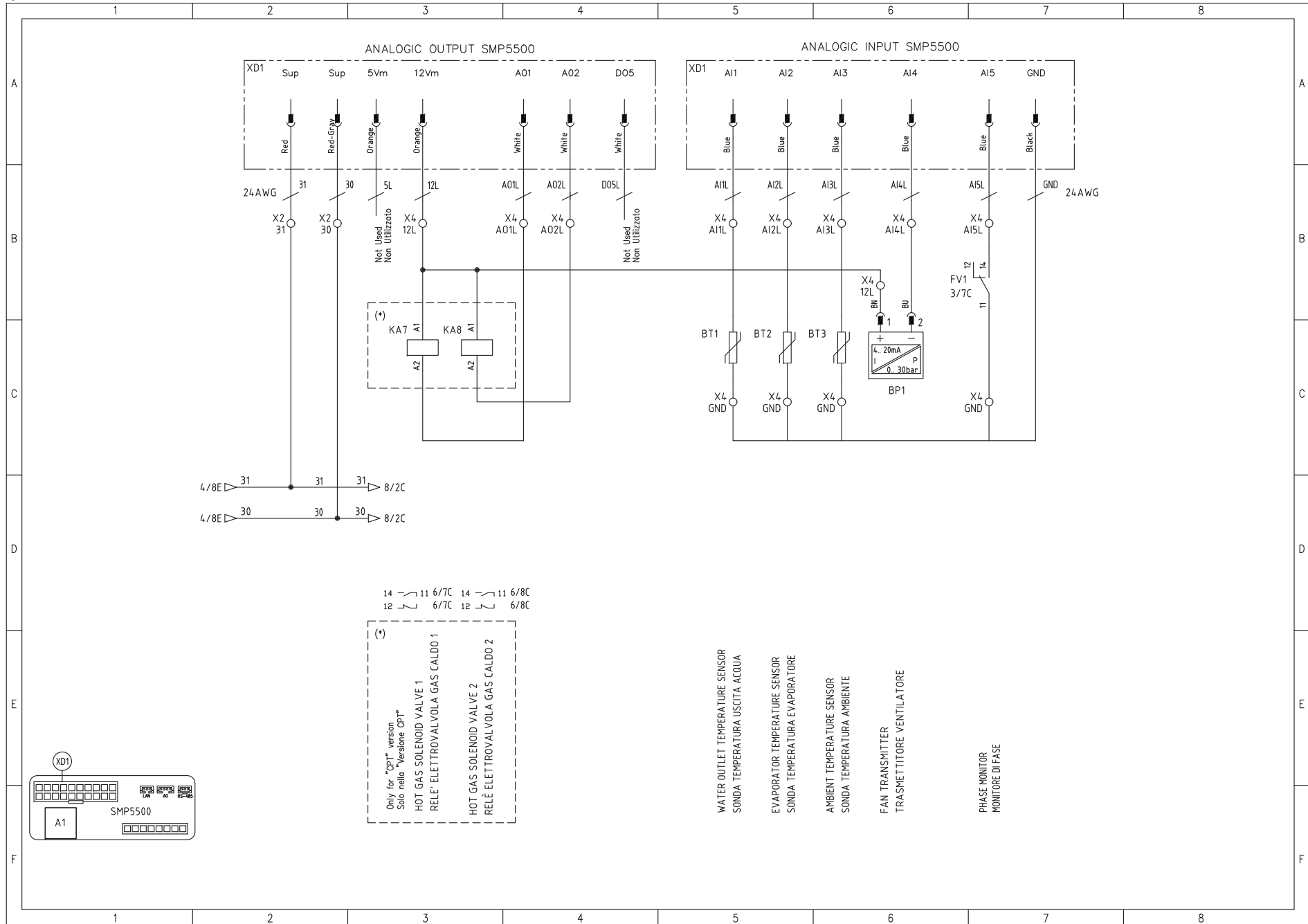

7.9 Wiring diagram ICEP008-015E (standard)

Sheet 6/15

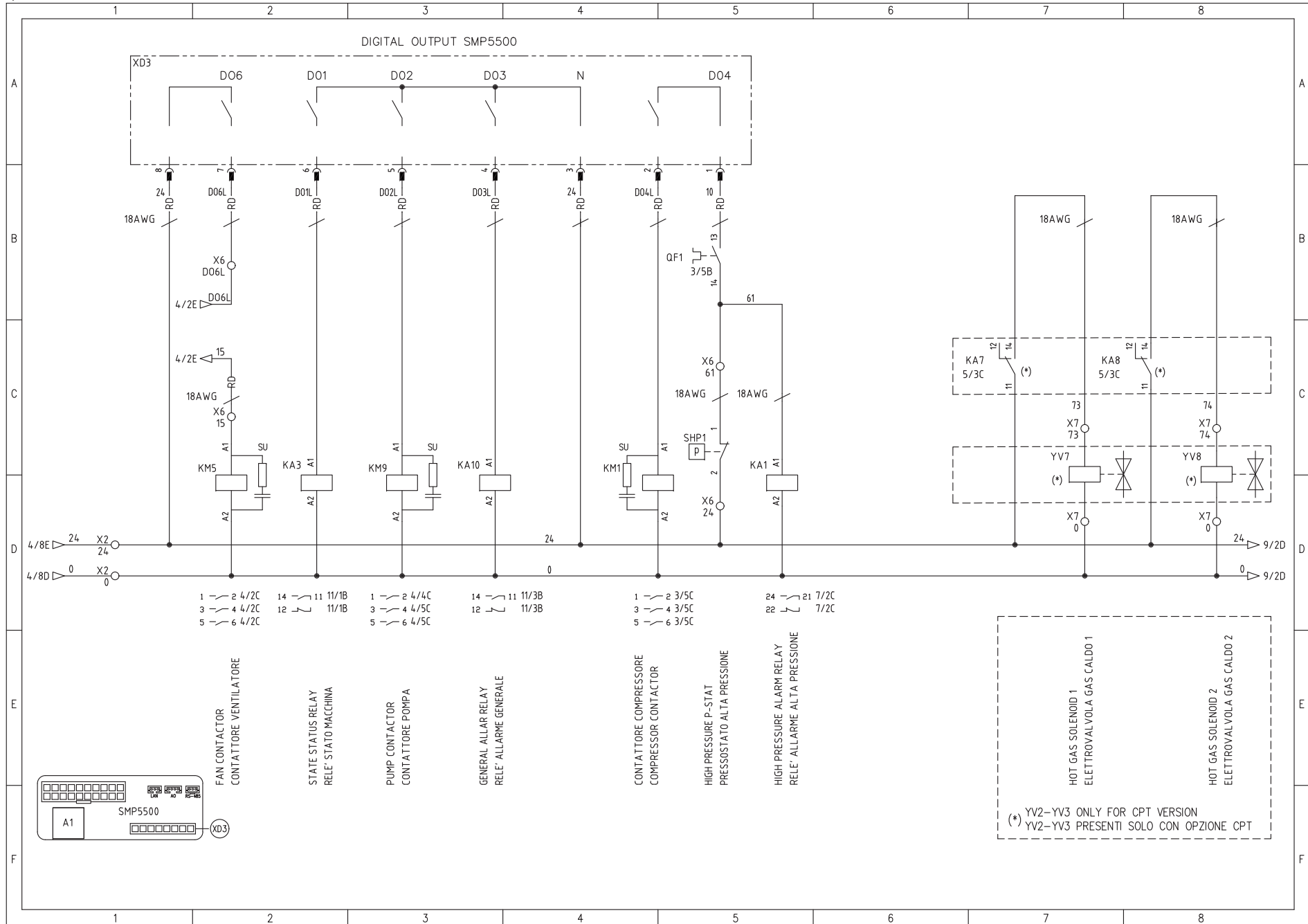

7.9 Wiring diagram ICEP008-015E (standard)

Sheet 7/15

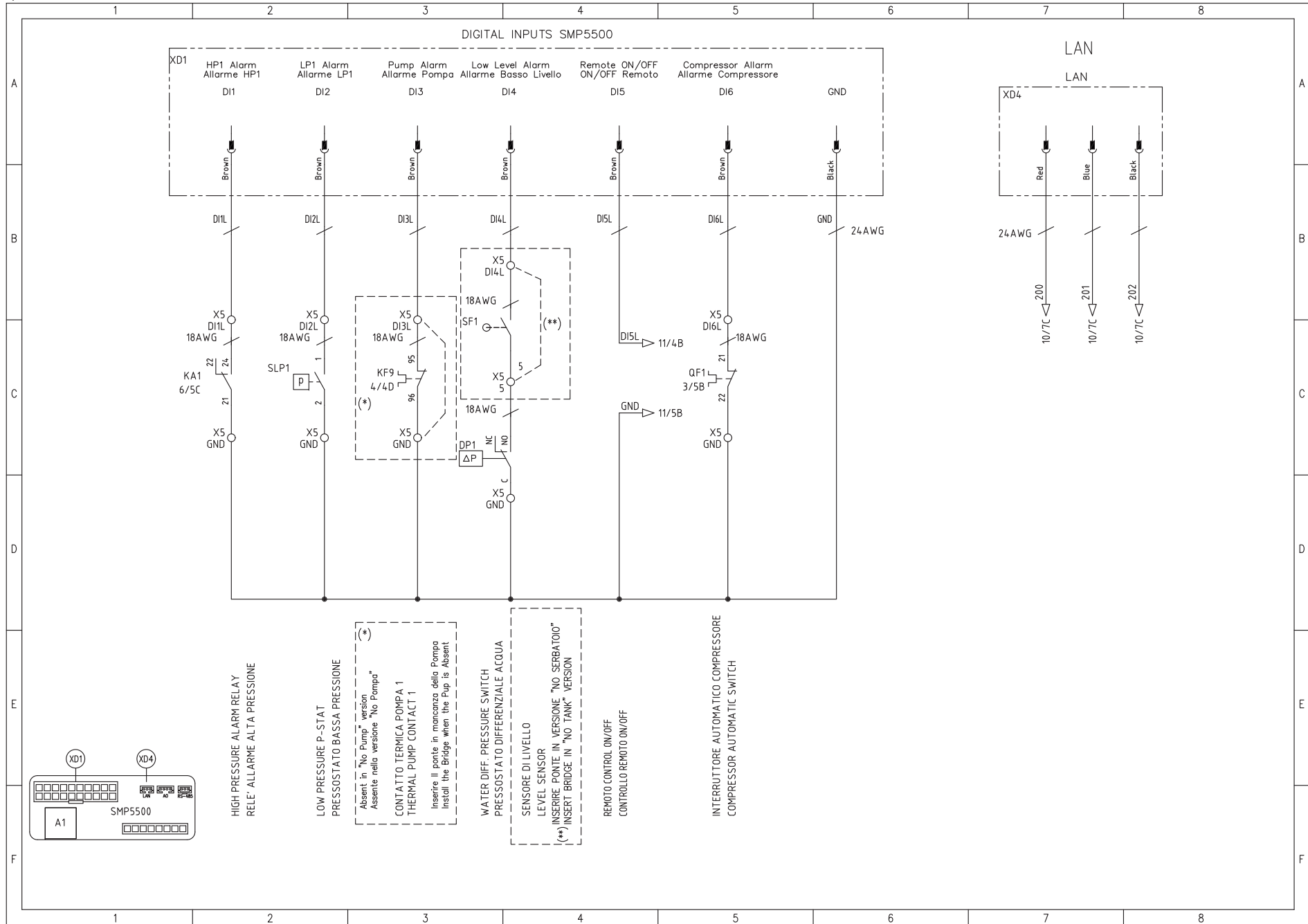

7.9 Wiring diagram ICEP008-015E (standard)

Sheet 8/15

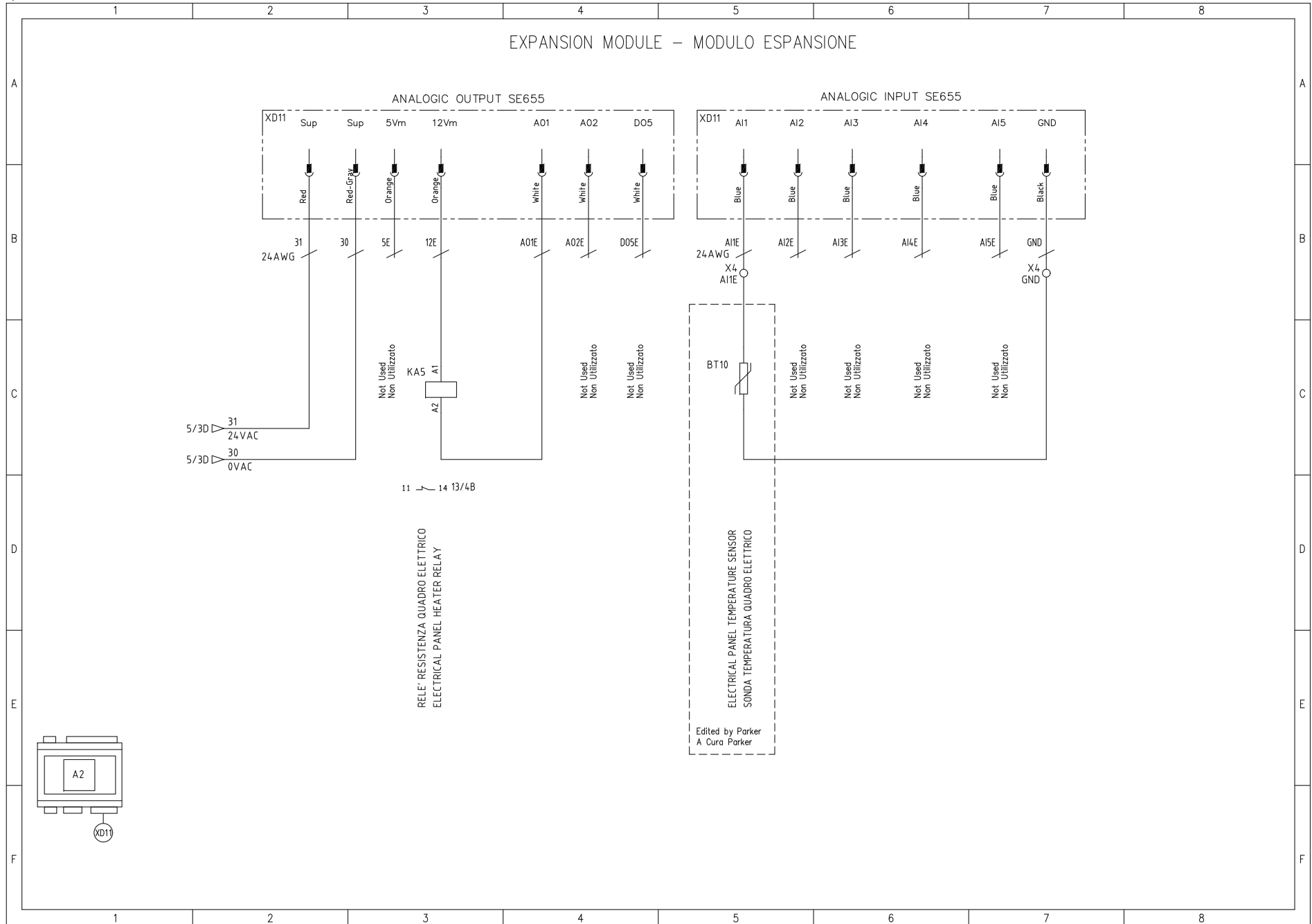

7.9 Wiring diagram ICEP008-015E (standard)

Sheet 9/15

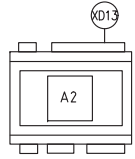
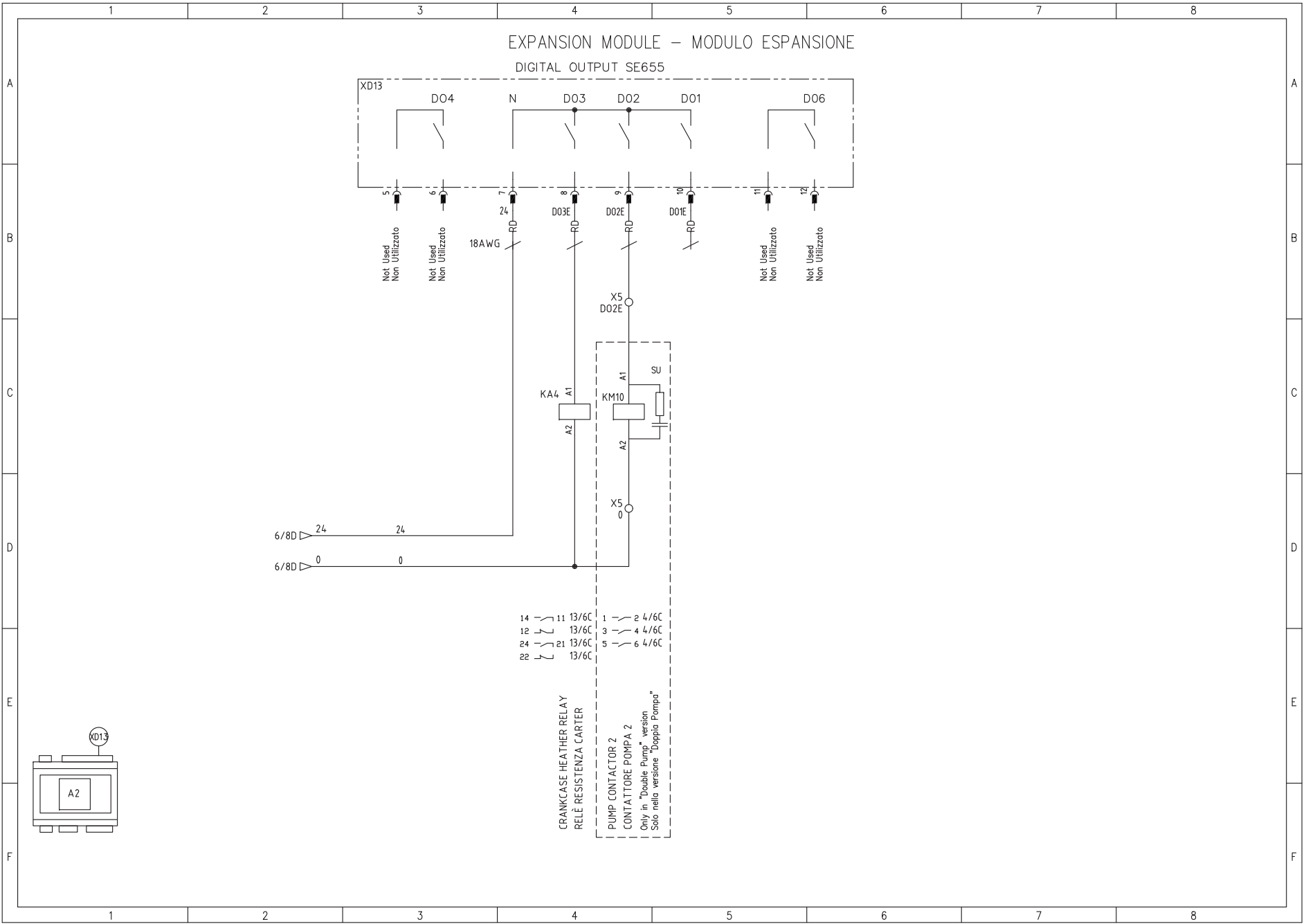

7.9 Wiring diagram ICEP008-015E (standard)

Sheet 10/15

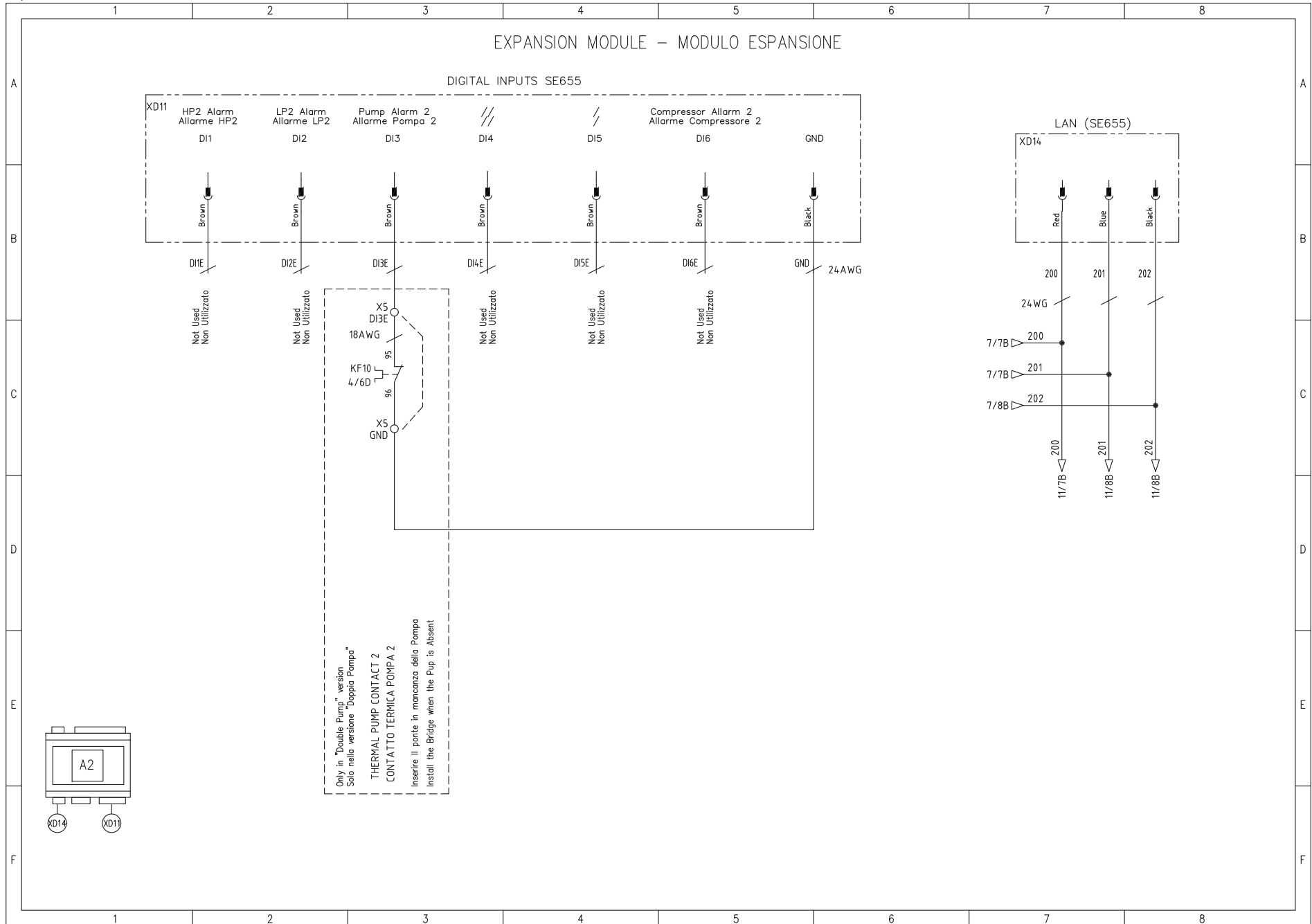

7.9 Wiring diagram ICEP008-015E (standard)

Sheet 11/15

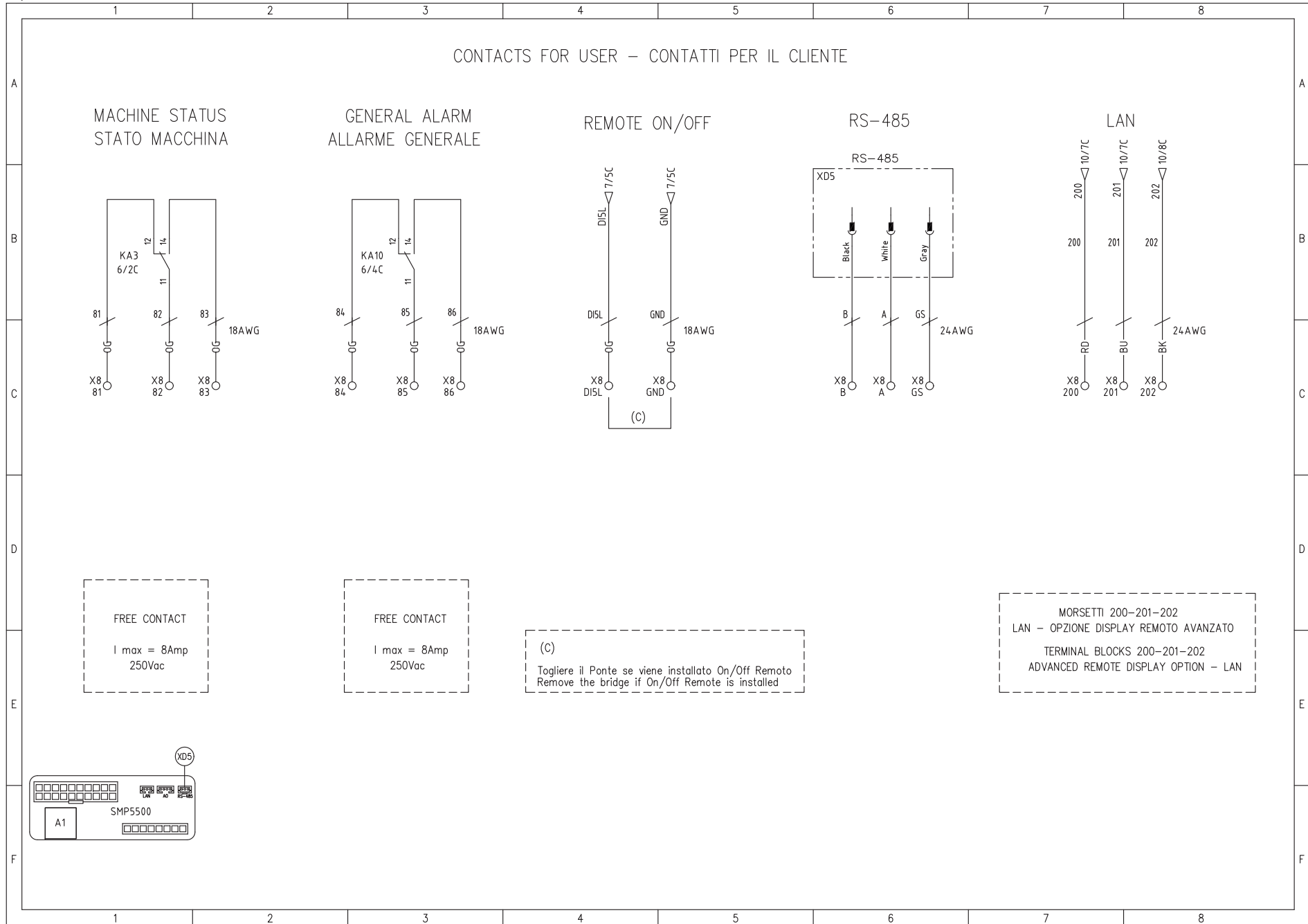

7.9 Wiring diagram ICEP008-015E (standard)

Sheet 12/15

OPTIONAL CONNECTIONS – COLLEGAMENTI OPZIONALI

ADVANCE REMOTE Control – OPTION – Consult Parker
 OPZIONE – Controllo Remoto Avanzato – Consultare Parker

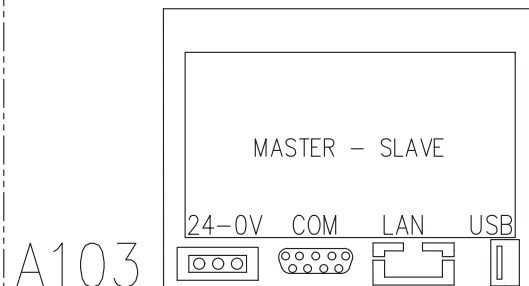

MODBUS TCP-IP – OPTION – Consult Parker
 OPZIONE – MODBUS TCP-IP – Consultare Parker

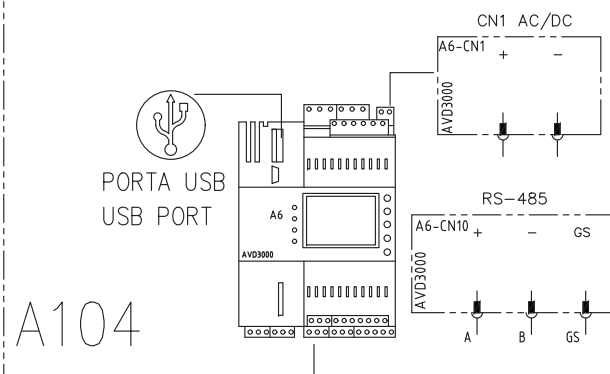

7.9 Wiring diagram ICEP008-015E (standard)

Sheet 13/15

OPTION TERMINAL BLOCKS – MORSETTI COLLEGAMENTI OPZIONI

Electrical Panel Heater
Resistenza Quadro Elettrico

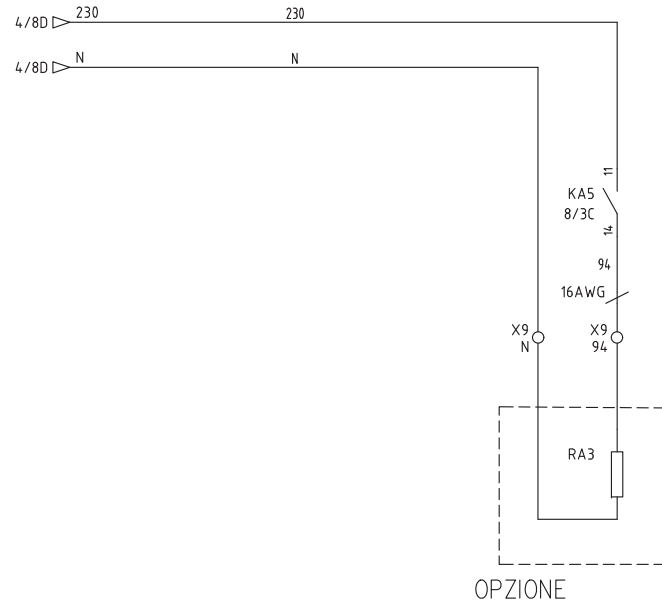

ELECTRICAL PANEL HEATHER
RESISTENZA QUADRO ELETRICO

Crankcase Heater Compressor
Resistenza Carter compressore

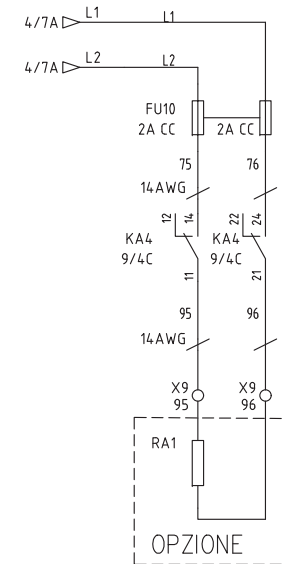

CRANKCASE HEATHER
RESISTENZA CARTER

7.9 Wiring diagram ICEP008-015E (standard)

Sheet 14/15

TERMINAL BLOCKS – MORSETTIERA 008–015

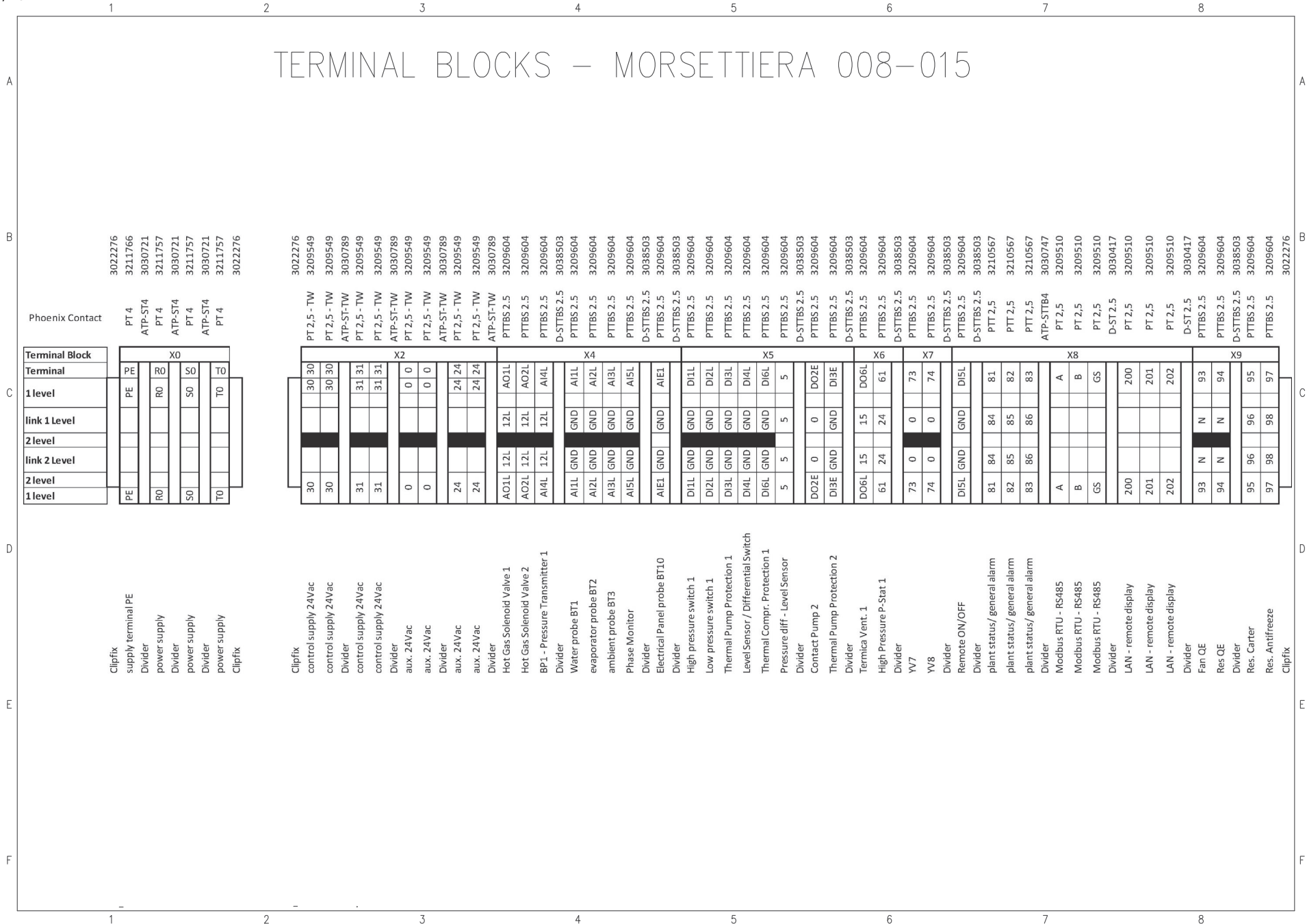

7.9 Wiring diagram ICEP008-015E (standard)

Sheet 15/15

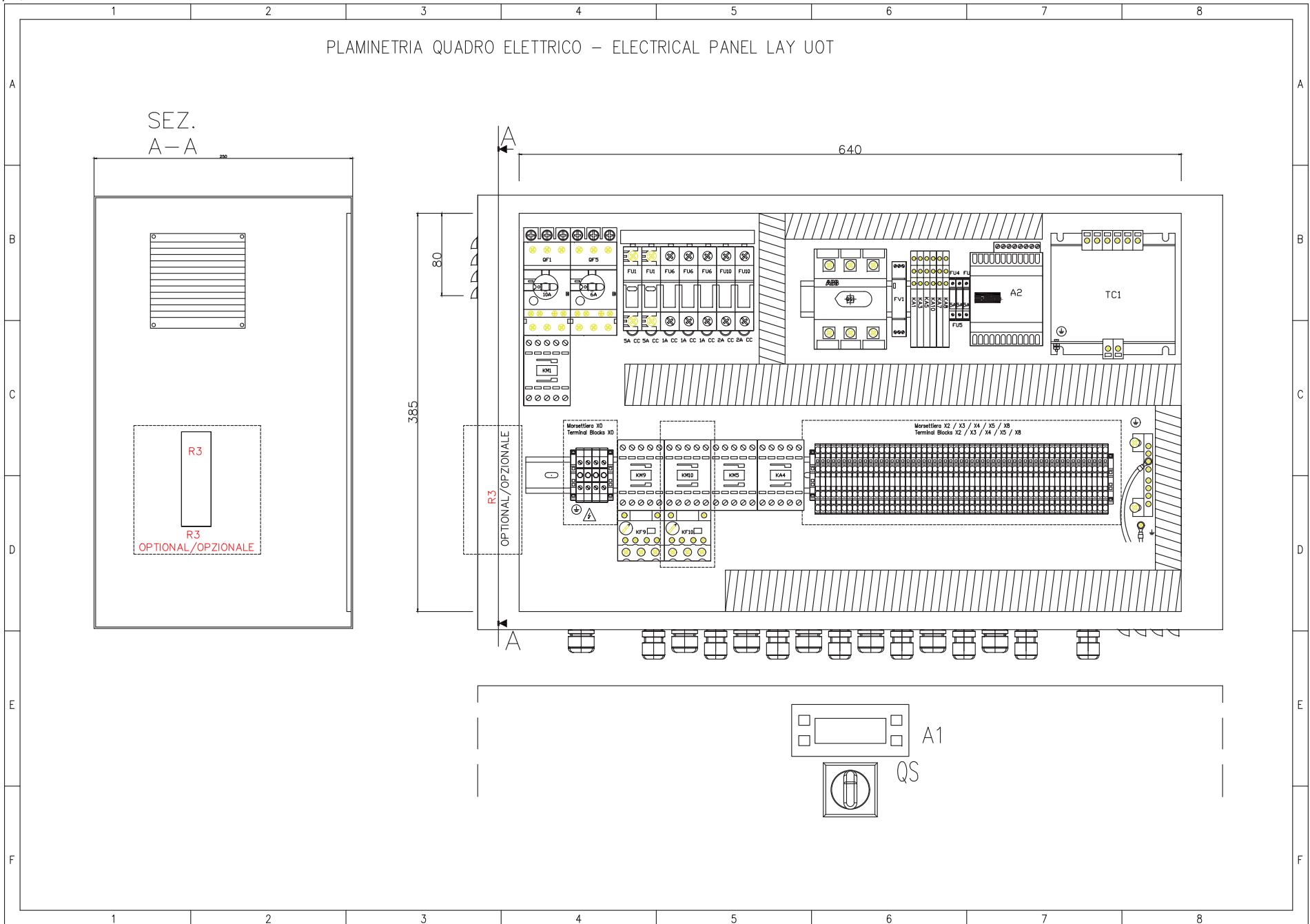

Wiring diagram ICEP022-027E (standard)

Sheet 1/15

MODEL MODELLO ICEP022	NOMINAL VOLTAGE TENSIONE NOMINALE Un (V) = 460				PHASES FASI Ph = 3				FREQUENCY FREQUENZA f (Hz) = 60				NOMINAL VOLTAGE TENSIONE NOMINALE Un (V) = 460				PHASES FASI Ph = 3				FREQUENCY FREQUENZA f (Hz) = 60				NOMINAL VOLTAGE TENSIONE NOMINALE Un (V) = 460V/3/60Hz			
	COMPRESSORS COMPRESSORI				FAN MOTOR ELETTROVENTILATORE				PUMP POMPA				MODEL - MODELLI ICEP022															
	SIGLA	FLA (A)	KW	LRA (A)	SIGLA	FLA (A)	KW	LRA (A)	SIGLA	FLA (A)	KW	LRA (A)	MCA (A)	MOP (A)	FLA (A) Tot.													
	M1- MC1	12.8	7.3 [10HP]	95	M2-EV1	1,02 λ	0,71 [1 HP]	5.1	M9-P1(P15)	/	/	/	/	/	/													
				M2-EV2	1,02 λ	0.71 [1 HP]	5.1	M9-P1(P30)	1.71	0.75 [1 HP]	14.11	20	30	16.55														
								M9-P1(P50)	2.42	1.1 [1.5 HP]	22.05	21	30	17.26														

MODEL MODELLO ICEP027	NOMINAL VOLTAGE TENSIONE NOMINALE Un (V) = 460				PHASES FASI Ph = 3				FREQUENCY FREQUENZA f (Hz) = 60				NOMINAL VOLTAGE TENSIONE NOMINALE Un (V) = 460				PHASES FASI Ph = 3				FREQUENCY FREQUENZA f (Hz) = 60				NOMINAL VOLTAGE TENSIONE NOMINALE Un (V) = 460V/3/60Hz			
	COMPRESSORS COMPRESSORI				FAN MOTOR ELETTROVENTILATORE				PUMP POMPA				MODEL - MODELLI ICEP027															
	SIGLA	FLA (A)	KW	LRA (A)	SIGLA	FLA (A)	KW	LRA (A)	SIGLA	FLA (A)	KW	LRA (A)	MCA (A)	MOP (A)	FLA (A) Tot.													
	M1- MC1	19.2	9.72 [15HP]	140	M2-EV1	1,02 λ	0,71 [1 HP]	5.1	M9-P1(P15)	/	/	/	/	/	/													
				M2-EV2	1,02 λ	0.71 [1 HP]	5.1	M9-P1(P30)	1.71	0.75 [1 HP]	14.11	28	45	22.95														
								M9-P1(P50)	3.14	1.5 [2 HP]	30.74	29.5	45	24.38														

FOLGIO/SHEET	DESCRIZIONE	DESCRIPTION
1	Dati Tecnici	Technical Data
2	Dati Tecnici	Technical Data
3	Circuito di Potenza	Power Circuit
4	Circuito di Potenza	Power Circuit
5	Circuito Ausiliario	Auxiliary Circuit
6	Circuito Ausiliario	Auxiliary Circuit
7	Circuito Ausiliario	Auxiliary Circuit
8	Modulo Espansione	Expansion Module
9	Modulo Espansione	Expansion Module
10	Modulo Espansione	Expansion Module
11	Contatti Cliente	Terminal Block for User
12	Collegamenti Opzionali	Optional Terminal Block
13	Collegamenti Opzionali	Optional Terminal Block
14	Morsettiera	Terminal Block
15	Planimetria Quadro Elettrico	Electrical Lay-Out
16	Lista Componenti	Component List
17	Lista Componenti	Component List
18	Lista Componenti	Component List
19	Lista Componenti	Component List
20	Lista Componenti Parker	Component List - Parker
21	Lista Componenti Parker	Component List - Parker

Model	Cod.
ICEP022-E	398H316454
ICEP027-E	398H316455

Wiring diagram ICEP022-027E (standard)

Sheet 2/15

	1	2	3	4	5	6	7	8																													
A	<table border="1"> <tr> <td>SUPPLY VOLTAGE TENSIONE ALIMENTAZIONE</td> <td>460V 3Ph 60Hz</td> </tr> <tr> <td>CONTROL VOLTAGE TENSIONE AUSILIARI</td> <td>0-24 VAC / 0-230 VAC</td> </tr> <tr> <td>ENCLOSED TYPE PROTEZIONE IP</td> <td>IP54</td> </tr> <tr> <td>RESIDUAL CURRENT SWITCH INTER. AUTOMATICO DIFFERENZIALE</td> <td>RCBO Id=0,03A CLASS A</td> </tr> <tr> <td>SCCR</td> <td>--</td> </tr> <tr> <td>GROUNDING MESSA A TERRA</td> <td>Solidly grounded</td> </tr> <tr> <td>CABLES SIZE SUPPLY CAVI INGRESSO ALIMENTAZIONE</td> <td>See Table (MCA)</td> </tr> </table>		SUPPLY VOLTAGE TENSIONE ALIMENTAZIONE	460V 3Ph 60Hz	CONTROL VOLTAGE TENSIONE AUSILIARI	0-24 VAC / 0-230 VAC	ENCLOSED TYPE PROTEZIONE IP	IP54	RESIDUAL CURRENT SWITCH INTER. AUTOMATICO DIFFERENZIALE	RCBO Id=0,03A CLASS A	SCCR	--	GROUNDING MESSA A TERRA	Solidly grounded	CABLES SIZE SUPPLY CAVI INGRESSO ALIMENTAZIONE	See Table (MCA)																					
SUPPLY VOLTAGE TENSIONE ALIMENTAZIONE	460V 3Ph 60Hz																																				
CONTROL VOLTAGE TENSIONE AUSILIARI	0-24 VAC / 0-230 VAC																																				
ENCLOSED TYPE PROTEZIONE IP	IP54																																				
RESIDUAL CURRENT SWITCH INTER. AUTOMATICO DIFFERENZIALE	RCBO Id=0,03A CLASS A																																				
SCCR	--																																				
GROUNDING MESSA A TERRA	Solidly grounded																																				
CABLES SIZE SUPPLY CAVI INGRESSO ALIMENTAZIONE	See Table (MCA)																																				
B																																					
C																																					
D	<table border="1"> <tr> <th colspan="3">Tightening Torque</th> </tr> <tr> <td colspan="3" style="text-align: center;">  </td> </tr> <tr> <th>Component</th> <th>Nm</th> <th>Lb*In</th> </tr> <tr> <td>3RV2011-4AA15</td> <td>4,5000</td> <td>40</td> </tr> <tr> <td>3RV2021-4CA10</td> <td>4,5000</td> <td>40</td> </tr> <tr> <td>OT025F3</td> <td>0,8000</td> <td>7</td> </tr> <tr> <td>OT040F3</td> <td>0,8000</td> <td>7</td> </tr> <tr> <td>BCH</td> <td>2,5000</td> <td>22,0000</td> </tr> <tr> <td>M4_8SFL</td> <td>0,8000</td> <td>7,0000</td> </tr> <tr> <td>FV1</td> <td>0,5000</td> <td>4,4000</td> </tr> </table>		Tightening Torque						Component	Nm	Lb*In	3RV2011-4AA15	4,5000	40	3RV2021-4CA10	4,5000	40	OT025F3	0,8000	7	OT040F3	0,8000	7	BCH	2,5000	22,0000	M4_8SFL	0,8000	7,0000	FV1	0,5000	4,4000					
Tightening Torque																																					
																																					
Component	Nm	Lb*In																																			
3RV2011-4AA15	4,5000	40																																			
3RV2021-4CA10	4,5000	40																																			
OT025F3	0,8000	7																																			
OT040F3	0,8000	7																																			
BCH	2,5000	22,0000																																			
M4_8SFL	0,8000	7,0000																																			
FV1	0,5000	4,4000																																			
E																																					
F																																					
	1	2	3	4	5	6	7	8																													

TABELLA COLORI CAVI - TABLE ELECTRICAL CABLES (Norme ANSI)		
NERO - BLACK	BK	Conduttore di Potenza Principale in AC/DC - Main Power Circuits AC and DC
AZZURRO - LIGHT BLUE	BU	Conduttore di Neutro - Neutral Conductor
ROSSO - RED	RD	Circuiti di Comando in Corrente Alternata AC 12-24-230VAC - Control Circuits in AC 12-24-230VAC
BLU SCURO - DARK BLUE	DBU	Circuiti di Comando in Corrente Continua DC 24VDC - Control Circuits in DC 24VDC
ARANCIONE - ORANGE	OG	Circuiti Segnali in Tensione - Voltage Signal Circuits
BIANCO - WHITE	WH	Circuiti di Misura - Measuring Circuits
GIALLO-VERDE	GNYE	Conduttore di Terra - Grounded Conductors

Wiring diagram ICEP022-027E (standard)

Sheet 3/15

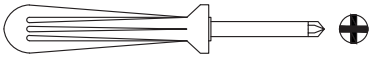
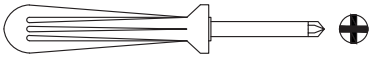
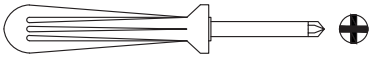
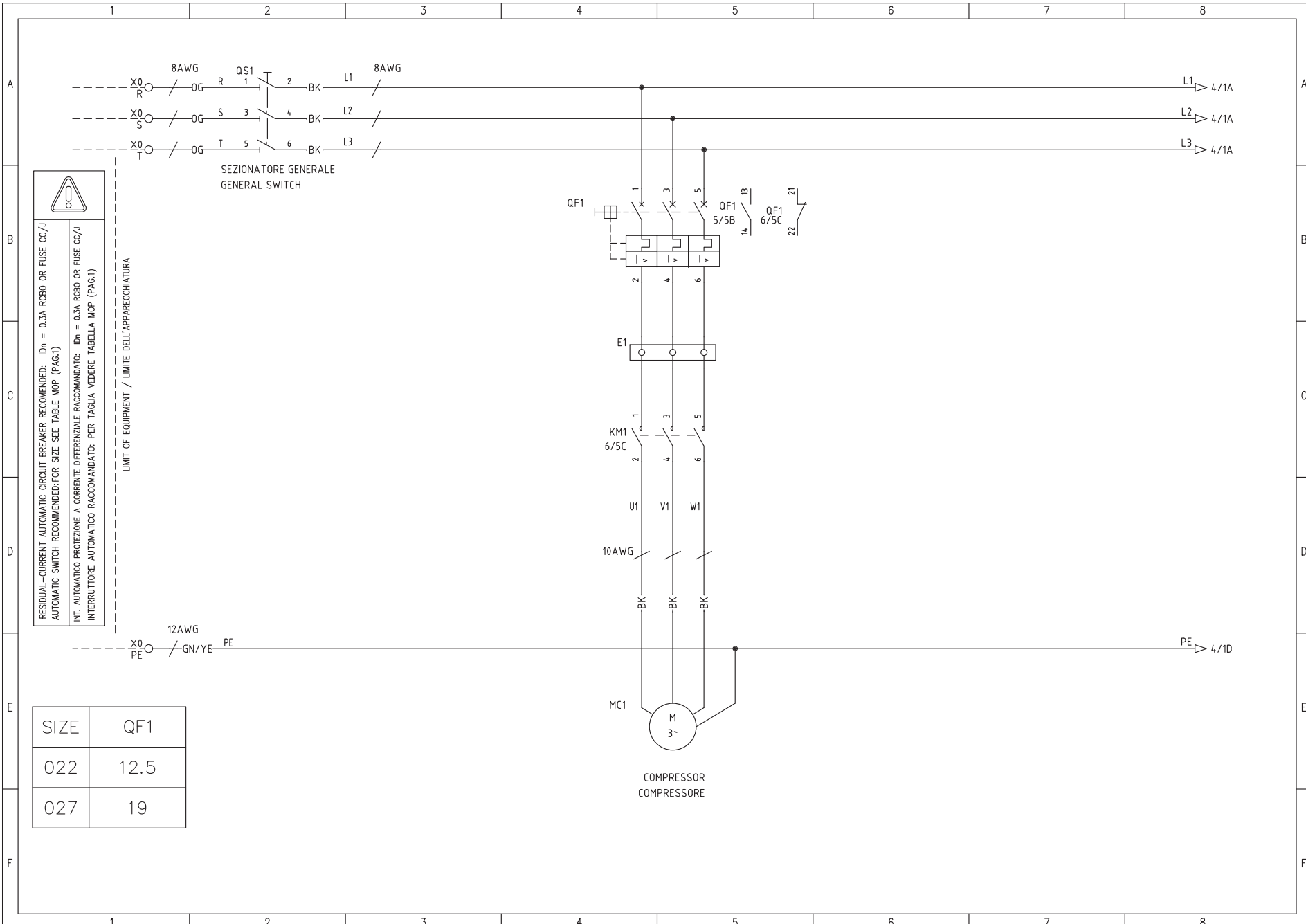

RESIDUAL-CURRENT AUTOMATIC CIRCUIT BREAKER RECOMMENDED: $I_{dn} = 0.3A$ RCBO OR FUSE CC/J
AUTOMATIC SWITCH RECOMMENDED: FOR SIZE SEE TABLE MOP (PAG.1)
INT. AUTOMATICO PROIEZIONE A CORRENTE DIFFERENZIALE RACCOMANDATO: $I_{dn} = 0.3A$ RCBO OR FUSE CC/J
INTERRUTTORE AUTOMATICO RACCOMANDATO: PER TAGLIA VEDERE TABELLA MOP (PAG.1)

LIMIT OF EQUIPMENT / LIMITE DELL'APPARECCHIATURA

SIZE	QF1
022	12.5
027	19

Wiring diagram ICEP022-027E (standard)

Sheet 4/15

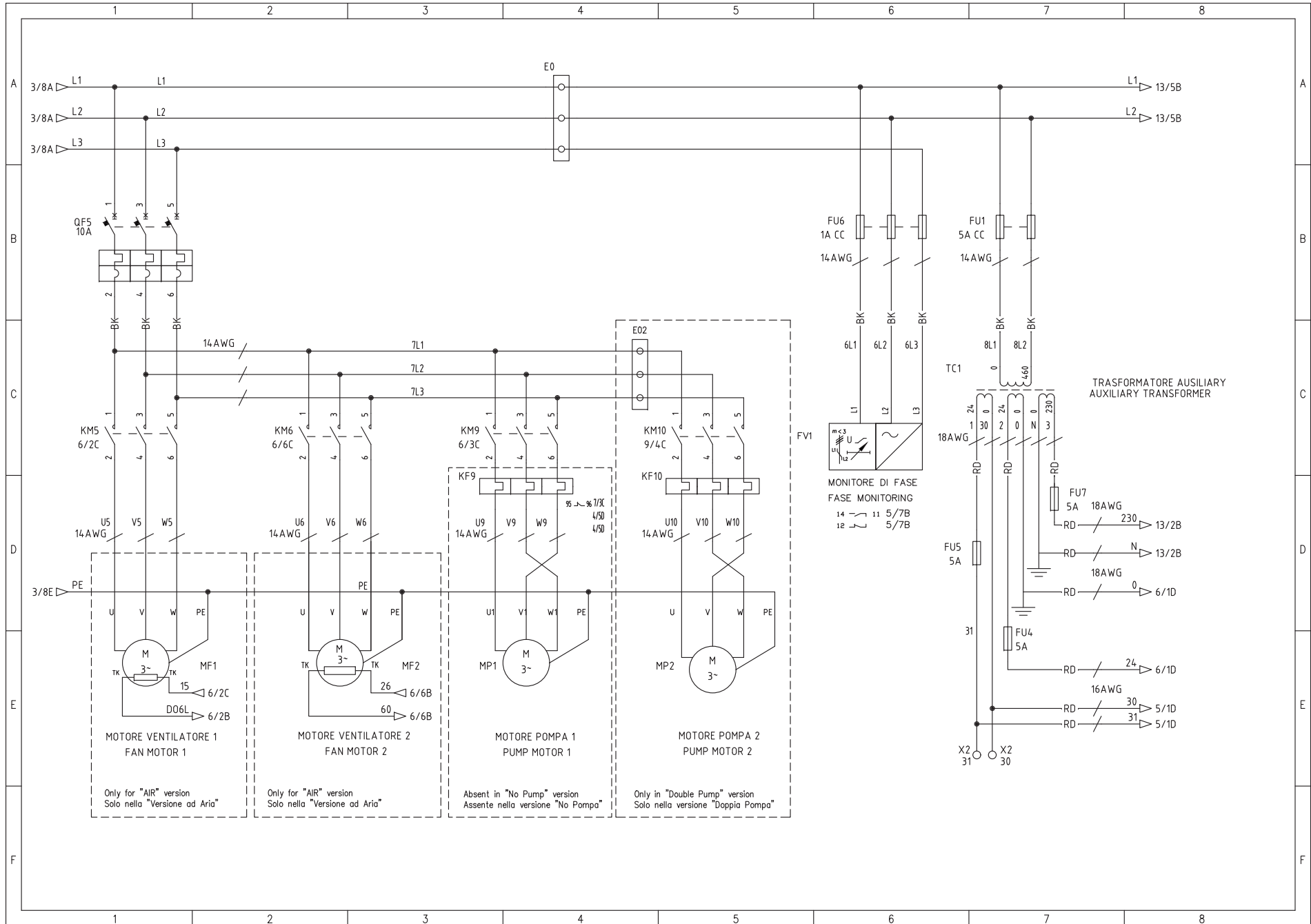

Wiring diagram ICEP022-027E (standard)

Sheet 5/15

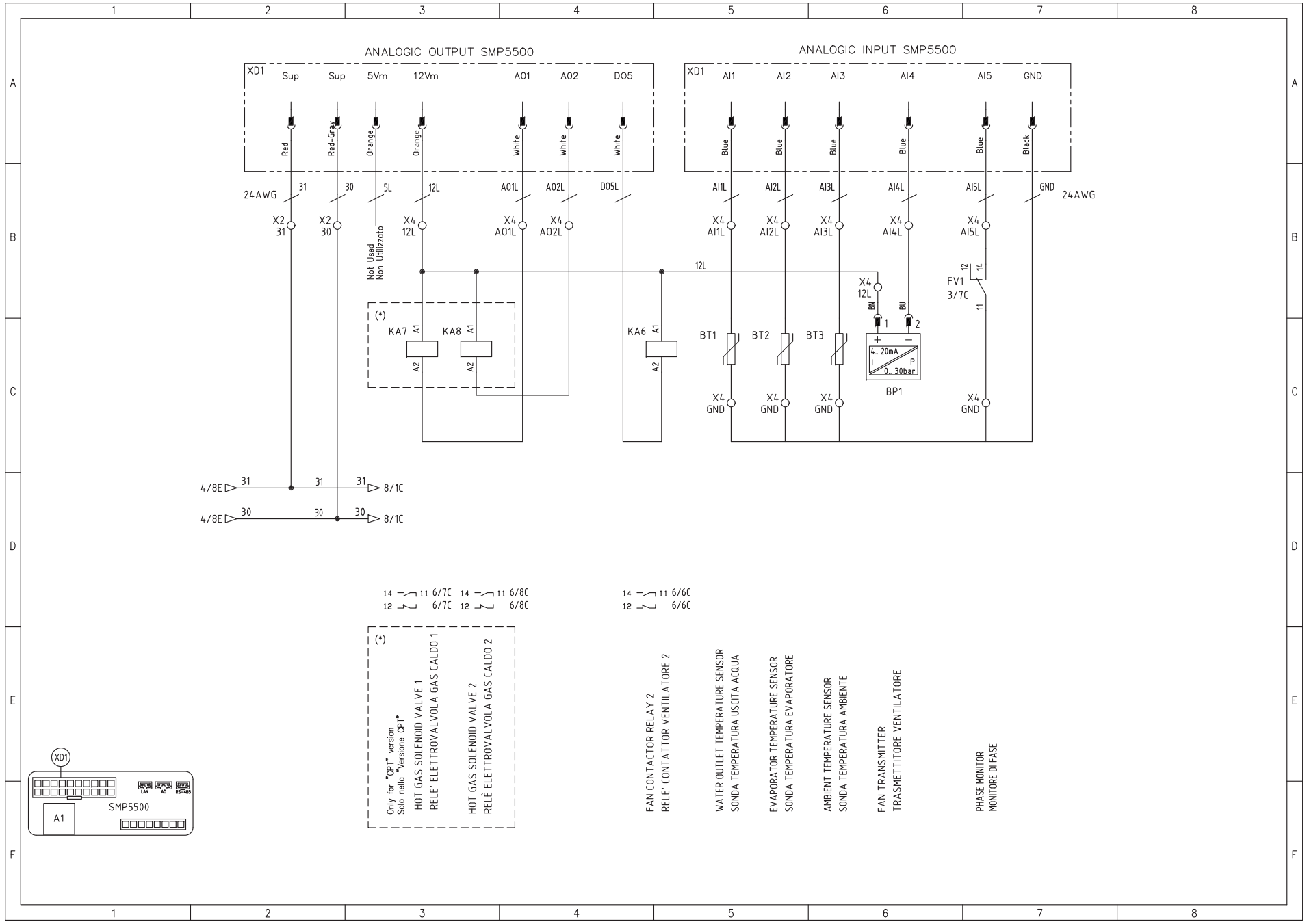

Wiring diagram ICEP022-027E (standard)

Sheet 6/15

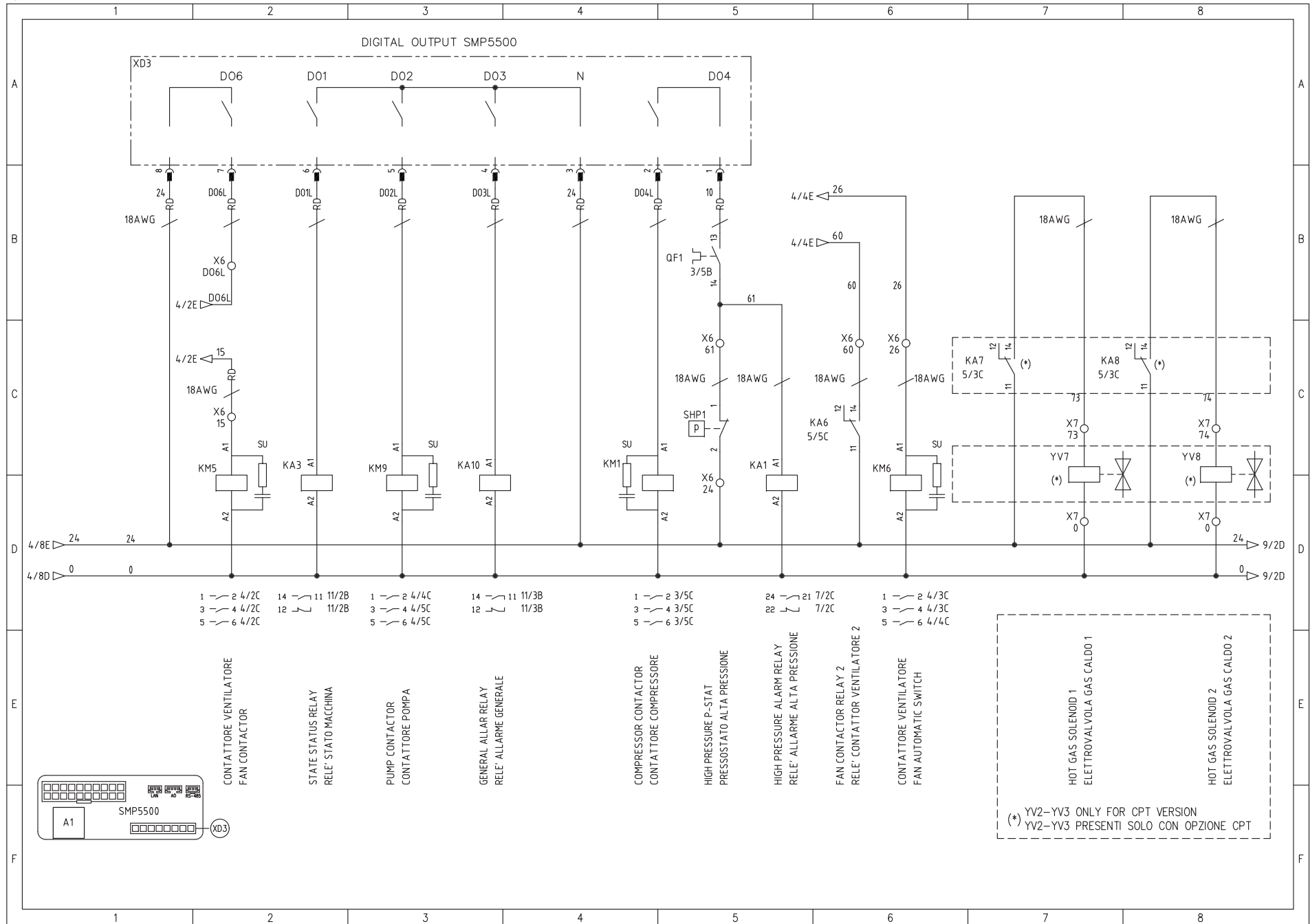

Wiring diagram ICEP022-027E (standard)

Sheet 7/15

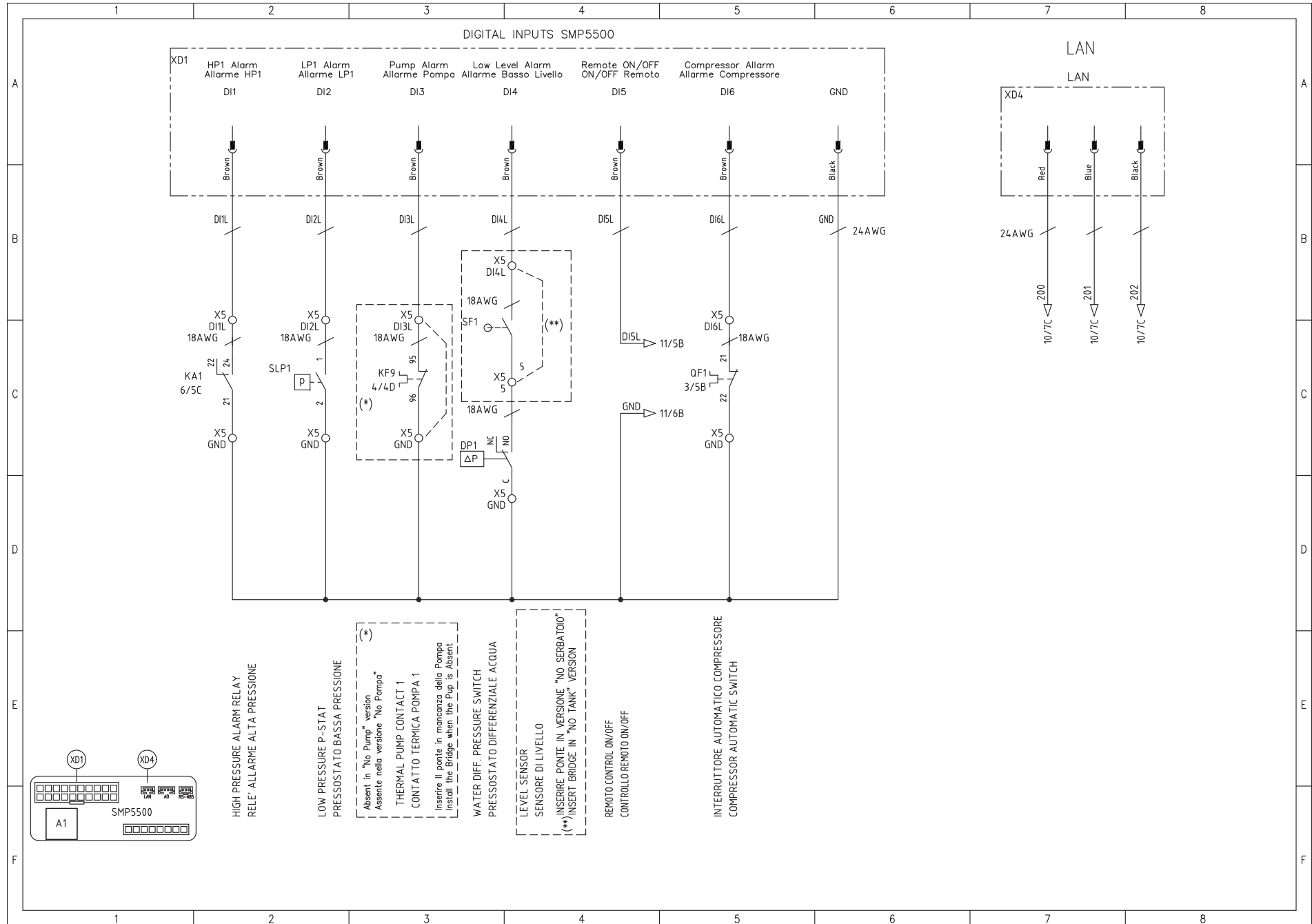

Wiring diagram ICEP022-027E (standard)

Sheet 8/15

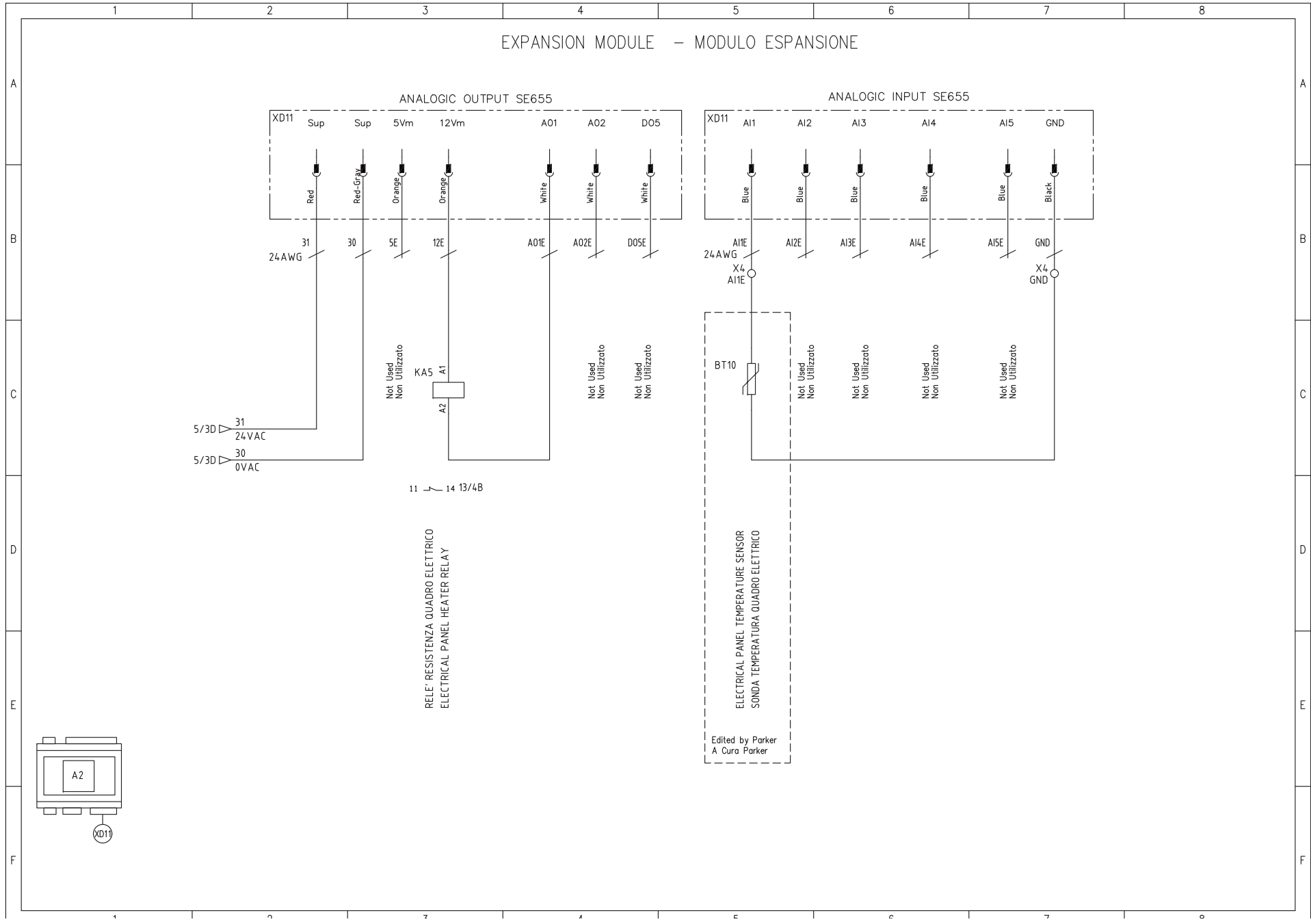

Wiring diagram ICEP022-027E (standard)

Sheet 9/15

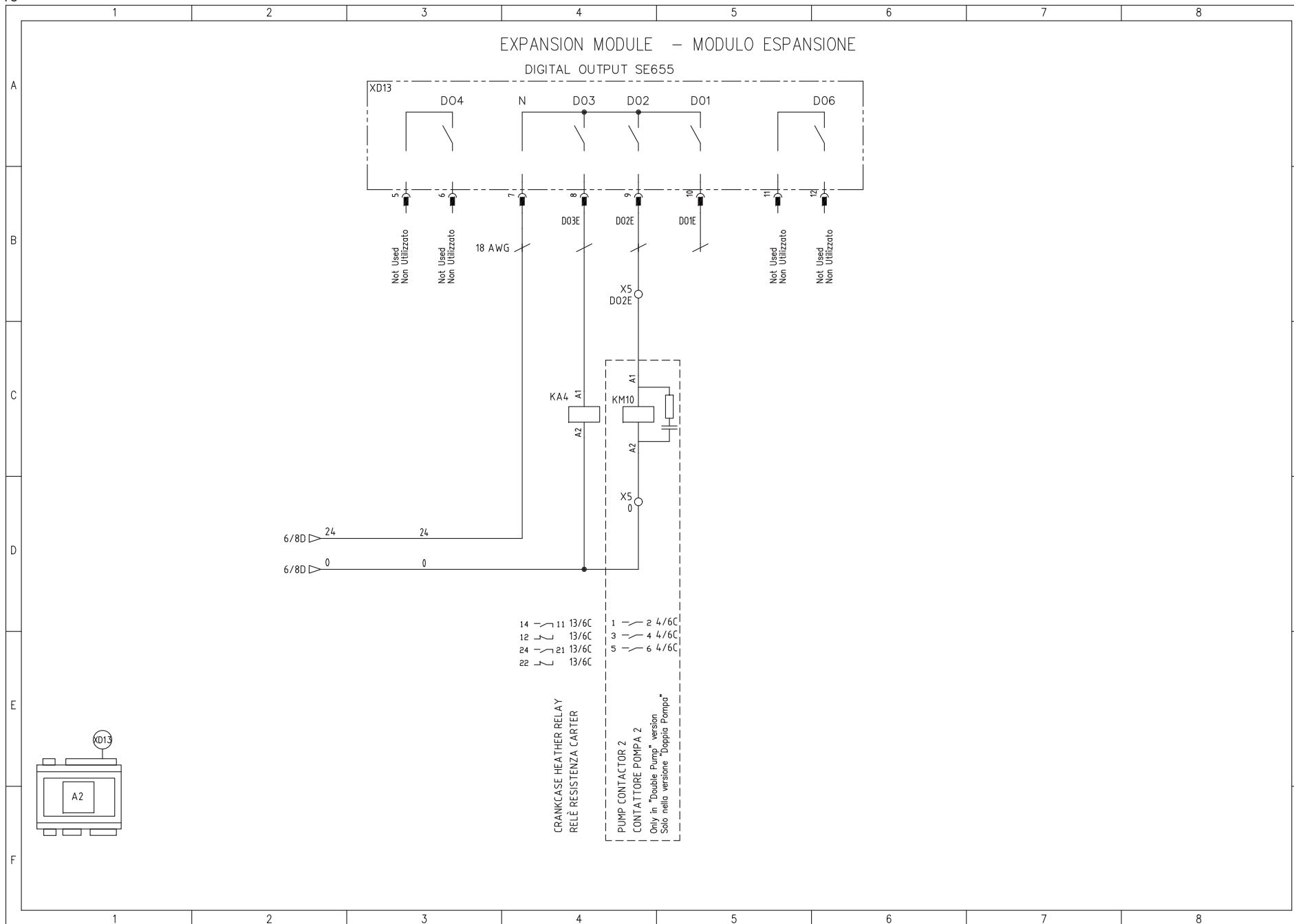

Wiring diagram ICEP022-027E (standard)

Sheet 10/15

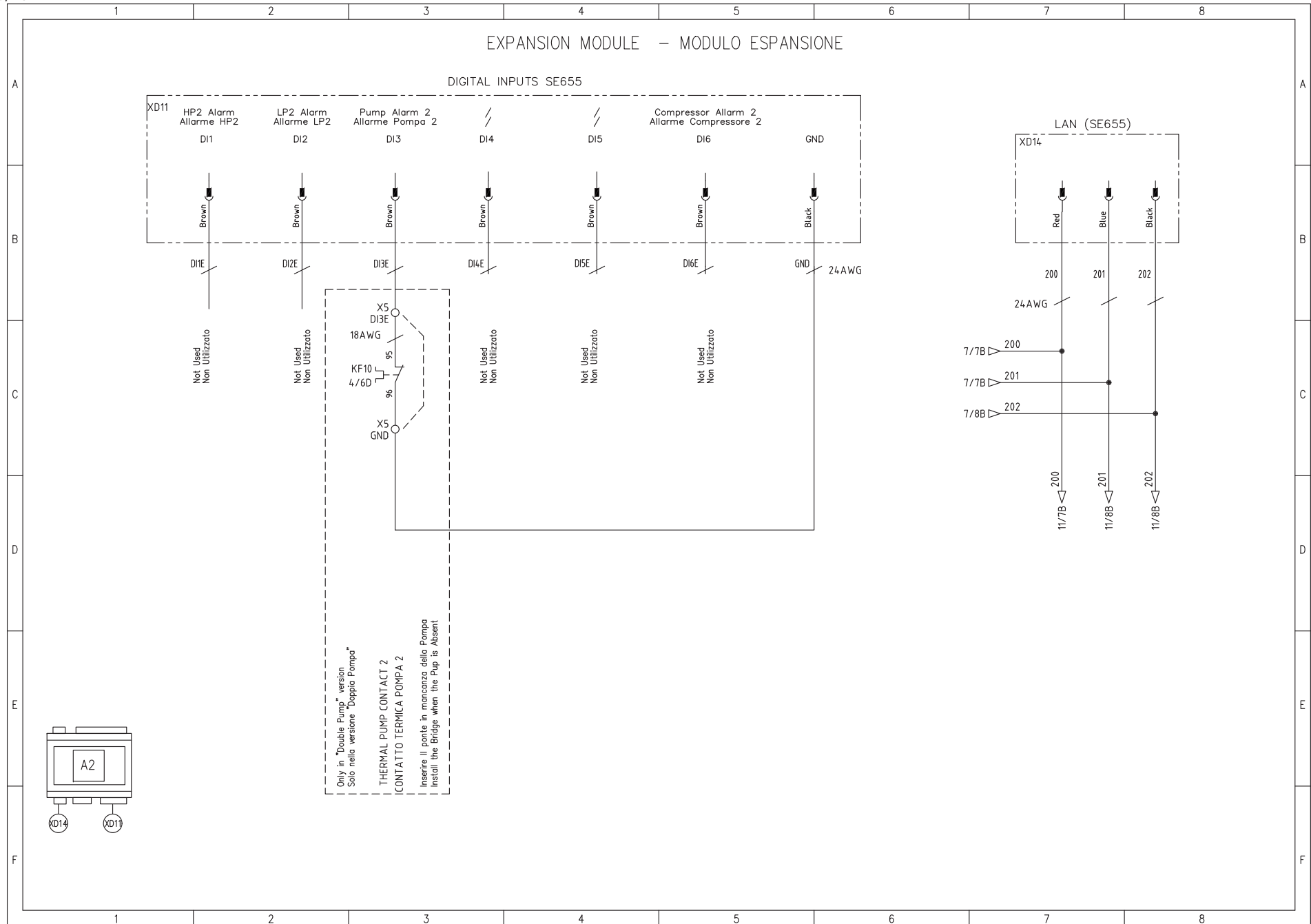

Wiring diagram ICEP022-027E (standard)

Sheet 11/15

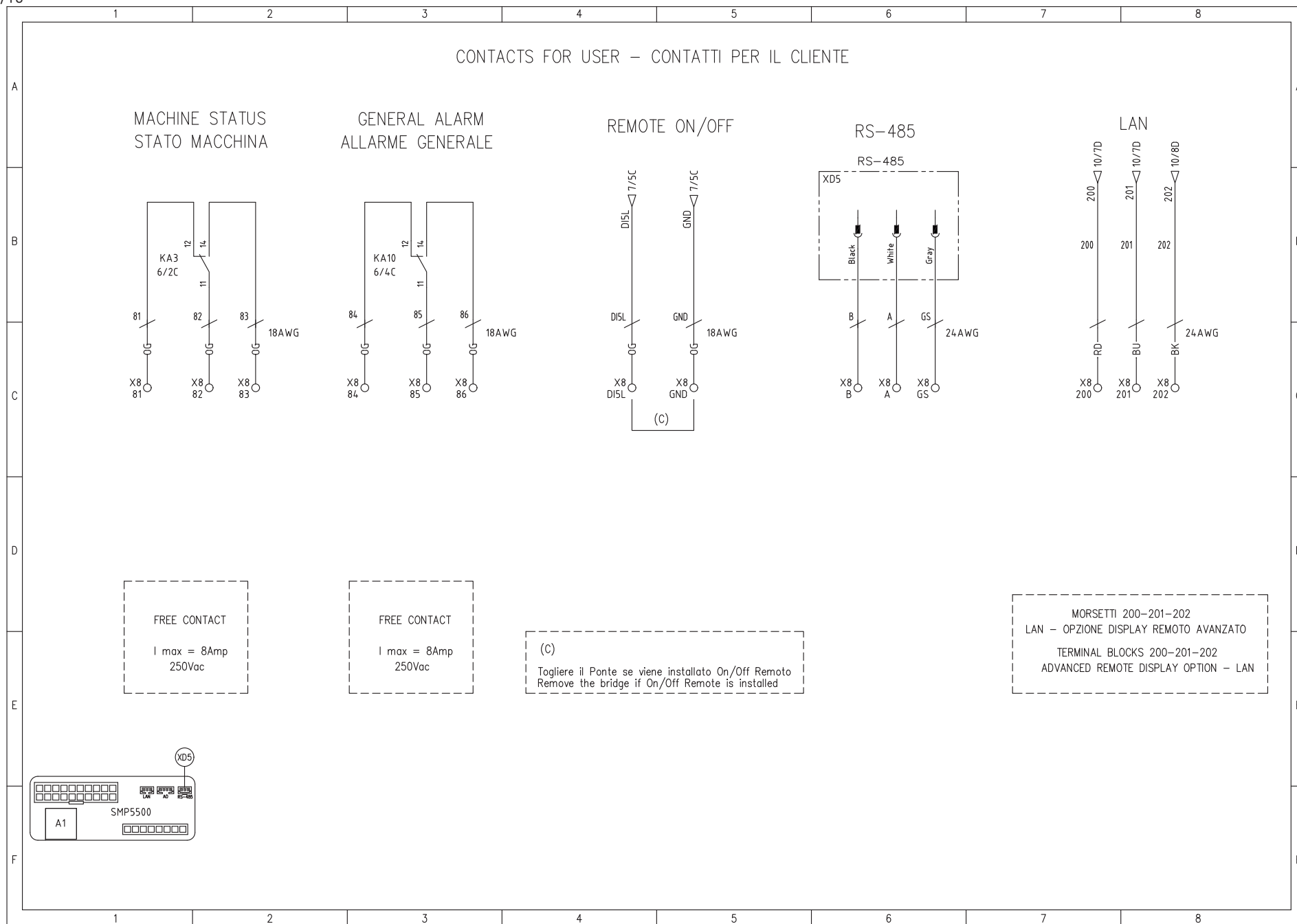

Wiring diagram ICEP022-027E (standard)

Sheet 12/15

OPTIONAL CONNECTIONS – COLLEGAMENTI OPZIONALI

ADVANCE REMOTE Control – OPTION – Consult Parker
 OPZIONE – Controllo Remoto Avanzato – Consultare Parker

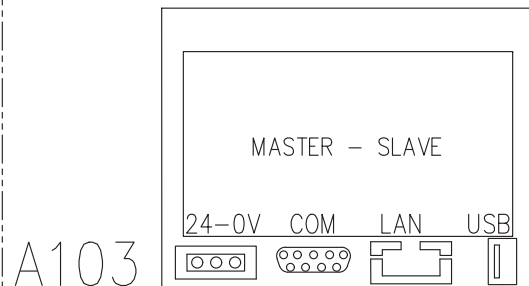

MODBUS TCP-IP – OPTION – Consult Parker
 OPZIONE – MODBUS TCP-IP – Consultare Parker

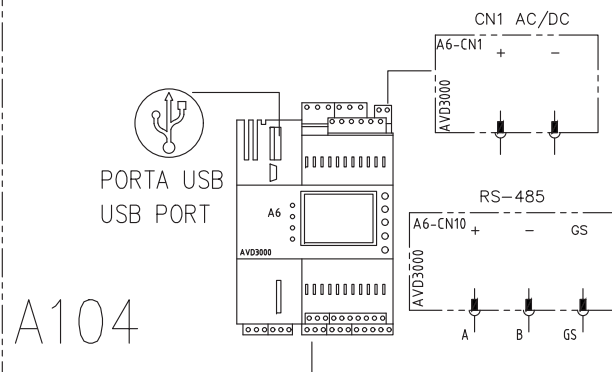

Wiring diagram ICEP022-027E (standard)

Sheet 13/15

OPTION TERMINAL BLOCKS – MORSETTI COLLEGAMENTI OPZIONI

Electrical Panel Heater
Resistenza Quadro Elettrico

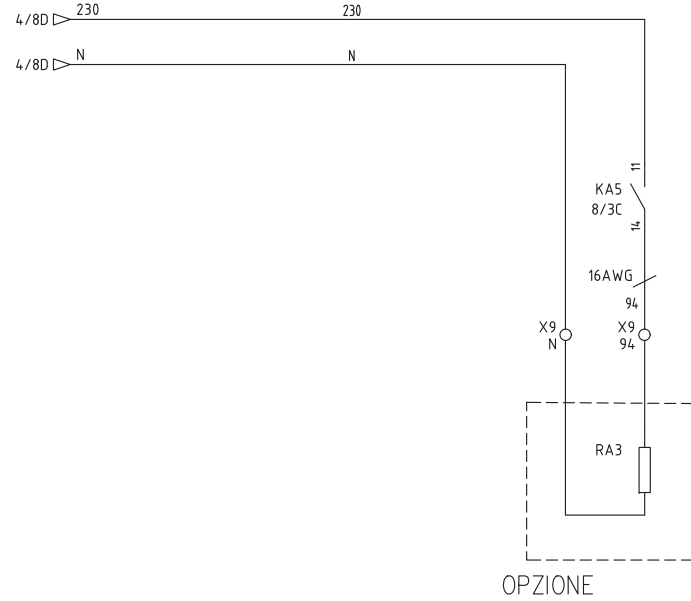

OPZIONE

ELECTRICAL PANEL HEATHER
RESISTENZA QUADRO ELETTTRICO

Crankcase Heater Compressor
Resistenza Carter compressore

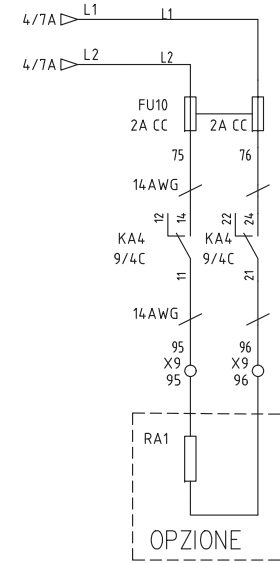

OPZIONE

CRANKCASE HEATHER
RESISTENZA CARTER

Wiring diagram ICEP022-027E (standard)

Sheet 14/15

TERMINAL BLOCKS – MORSETTIERA 022–027

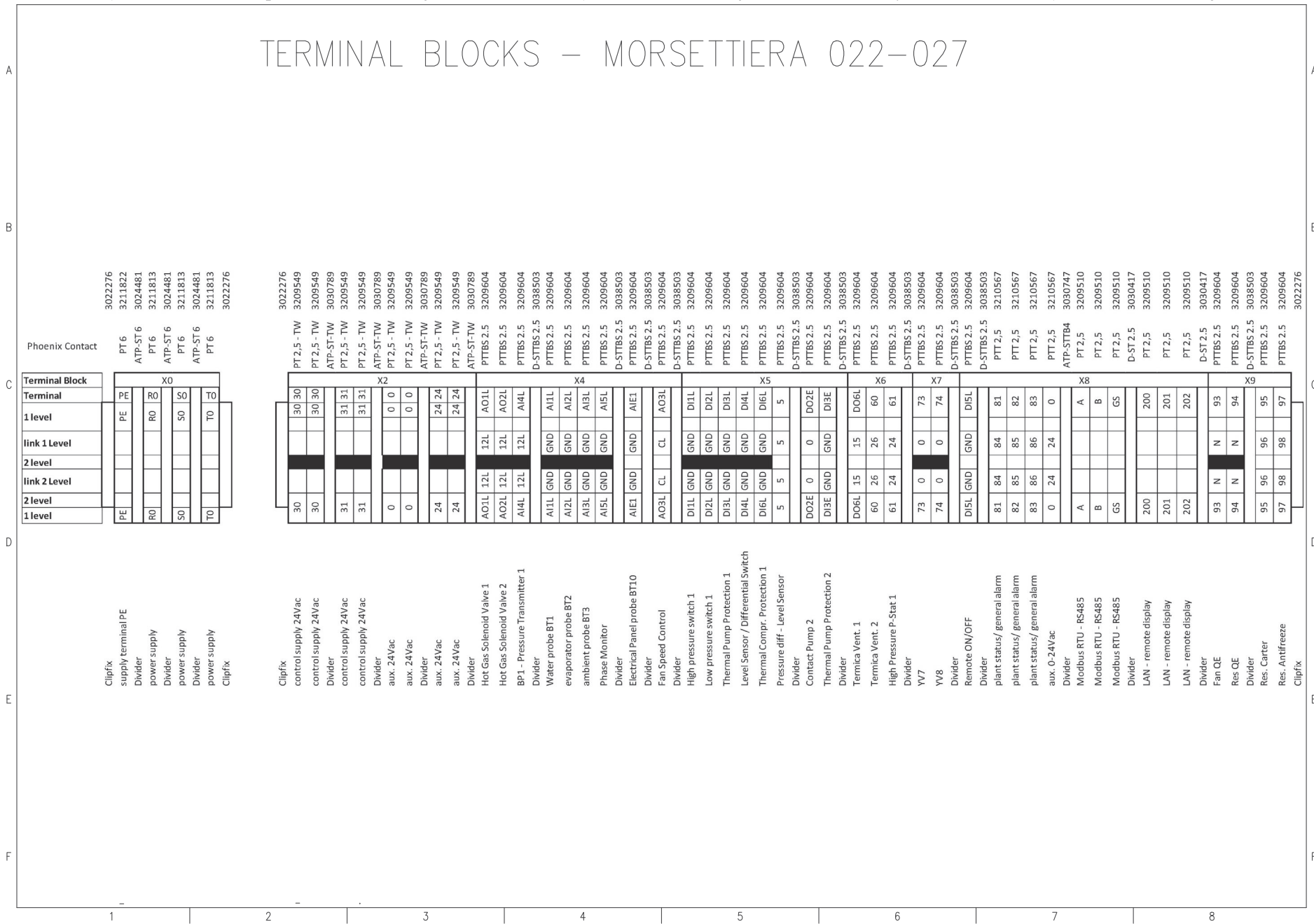

Phoenix Contact

3022276	PT 6
3211822	ATP-ST 6
3024481	PT 6
3211813	ATP-ST 6
3024481	PT 6
3211813	ATP-ST 6
3024481	PT 6
3211813	ATP-ST 6
3022276	PT 6

Terminal Block	
Terminal	
1 level	PE
link 1 Level	RO
2 level	SO
link 2 Level	TO
2 level	
1 level	

X2		X4		X5		X6		X7		X8		X9	
30	30	AO1L	12L	D11L	GND	DO6L	15	73	0	A		200	
30	30	AO2L	12L	D12L	GND	60	26	74	0	B		201	
31	31	A14L	12L	D13L	GND	61	24	0		G5		202	
31	31	A11L	GND	D14L	GND	5	5					93	N
0	0	A12L	GND	D16L	GND	DO2E	0					94	N
0	0	A13L	GND	5	5	D18E	GND					95	96
24	24	A15L	GND									97	98
24	24	AIE1	GND									98	98
		AO3L	CL									97	98
		D11L	GND									97	98
		D12L	GND									97	98
		D13L	GND									97	98
		D14L	GND									97	98
		D16L	GND									97	98
		5	5									97	98
		DO2E	0									97	98
		D18E	GND									97	98
		DO6L	15									97	98
		60	26									97	98
		61	24									97	98
		73	0									97	98
		74	0									97	98
		D15L	GND									97	98
		81	84									97	98
		82	85									97	98
		83	86									97	98
		0	24									97	98
		A										97	98
		B										97	98
		G5										97	98
		200										97	98
		201										97	98
		202										97	98
		93	N									97	98
		94	N									97	98
		95	96									97	98
		97	98									97	98

Clipfix
 supply terminal PE
 Divider
 power supply
 Divider
 power supply
 Divider
 power supply
 Clipfix

Clipfix
 control supply 24Vac
 control supply 24Vac
 Divider
 control supply 24Vac
 control supply 24Vac
 Divider
 aux. 24Vac
 aux. 24Vac
 Divider
 aux. 24Vac
 aux. 24Vac
 Divider
 Hot Gas Solenoid Valve 1
 Hot Gas Solenoid Valve 2
 BP1 - Pressure Transmitter 1
 Divider
 Water probe BT1
 evaporator probe BT2
 ambient probe BT3
 Phase Monitor
 Divider
 Electrical Panel probe BT10
 Divider
 Fan Speed Control
 Divider
 High pressure switch 1
 Low pressure switch 1
 Thermal Pump Protection 1
 Level Sensor / Differential Switch
 Thermal Compr. Protection 1
 Pressure diff - Level Sensor
 Divider
 Contact Pump 2
 Thermal Pump Protection 2
 Divider
 Termica Vent. 1
 Termica Vent. 2
 High Pressure P-Stat 1
 Divider
 YV7
 YV8
 Divider
 Remote ON/OFF
 Divider
 plant status/ general alarm
 plant status/ general alarm
 plant status/ general alarm
 aux. 0-24Vac
 Divider
 Modbus RTU - RS485
 Modbus RTU - RS485
 Modbus RTU - RS485
 Divider
 LAN - remote display
 LAN - remote display
 LAN - remote display
 Divider
 Fan QE
 Res QE
 Divider
 Res. Carter
 Res. Antifreeze
 Clipfix

Wiring diagram ICEP022-027E (standard)

Sheet 15/15

PLAMINETRIA QUADRO ELETTRICO – ELECTRICAL PANEL LAY UOT

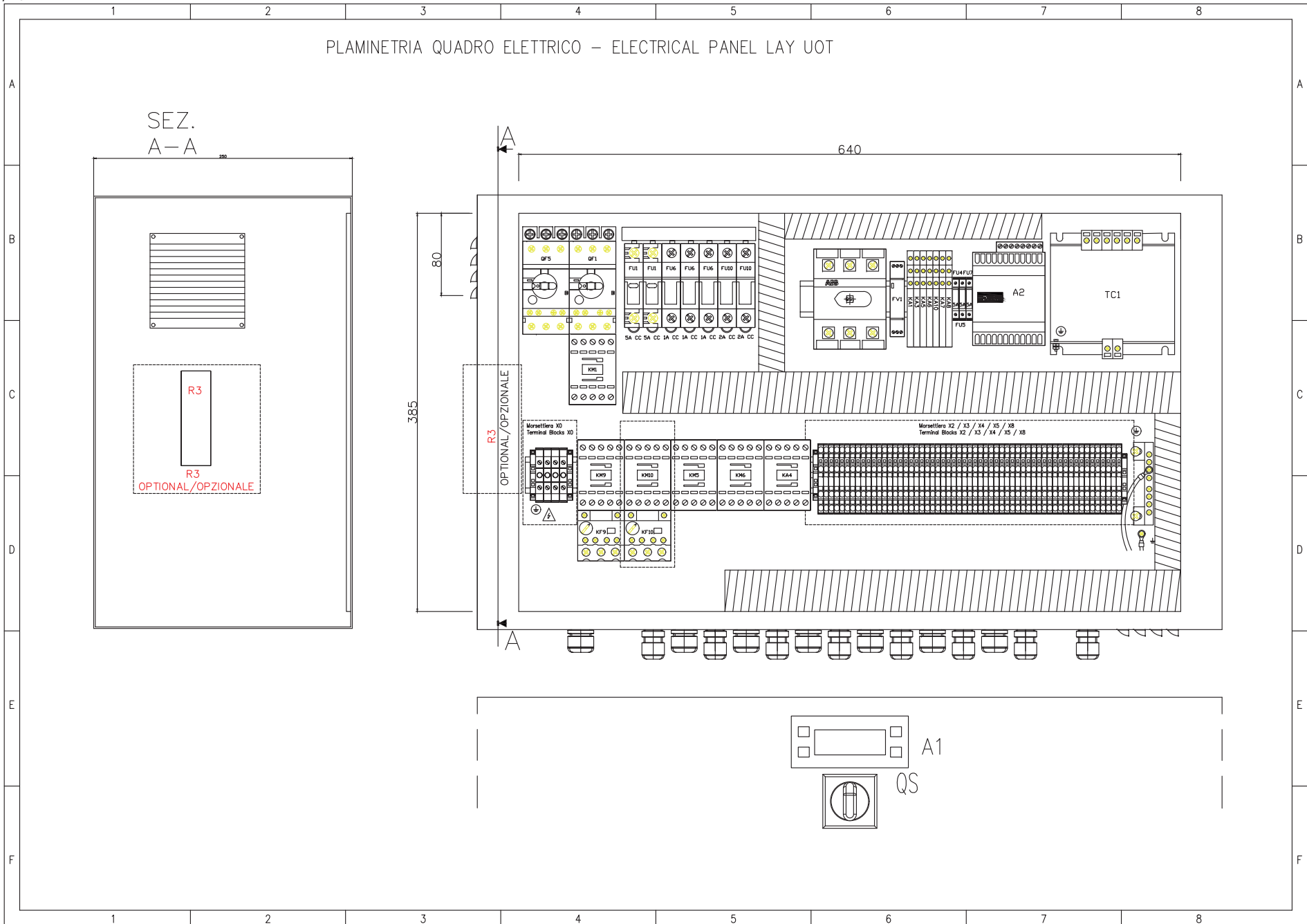





A division of Parker Hannifin Corporation

Parker Hannifin Corporation

Industrial Gas Filtration and Generation Division

4087 Walden Avenue

Lancaster, NY 14086

Tel: + 1 800 343 4048

Web site: www.parker.com/igfg

E-mail: gsfsupport@parker.com

Parker Hannifin Manufacturing S.r.l.

Sede Legale: Via Sebastiano Caboto 1, Palazzina "A" 20094 Corsico (MI) Italy

Sede Operativa: **Gas Separation and Filtration Division EMEA** - Strada Zona Industriale,

435020 S. Angelo di Piove (PD) Italy

tel +39 049 971 2111- fax +39 049 9701911

Web-site: www.parker.com